



Univerzitet u Beogradu – Građevinski fakultet
www.grf.bg.ac.rs

Studijski program: **GRAĐEVINARSTVO**

Modul: **PŽA, HVE, MTI**

Godina/Semestar: **III godina / V semestar**

Naziv predmeta (šifra): **Betonske konstrukcije 1**
(B2S3BK, B2H3BK, B2M3BK, B1S3BK)

Nastavnik: **Jelena Dragaš**

Naslov predavanja: **Krstasto armirane ploče – dimenzionisanje.**

Datum : **23.12.2022.**

Beograd, 2021.

Sva autorska prava autora prezentacije i/ili video snimaka su zaštićena. Snimak ili prezentacija se mogu koristiti samo za nastavu na daljinu studenta Građevinskog fakulteta Univerziteta u Beogradu u školskoj 2021/2022. i ne mogu se koristiti za druge svrhe bez pismene saglasnosti autora materijala.

Krstasto armirane ploče

Da bi ploča prenosila opterećenje u 2 pravca, potrebno je da bude oslonjena:

- na dve upravne ivice (c),
- na tri ivice (b),
- na četiri ivice (a).

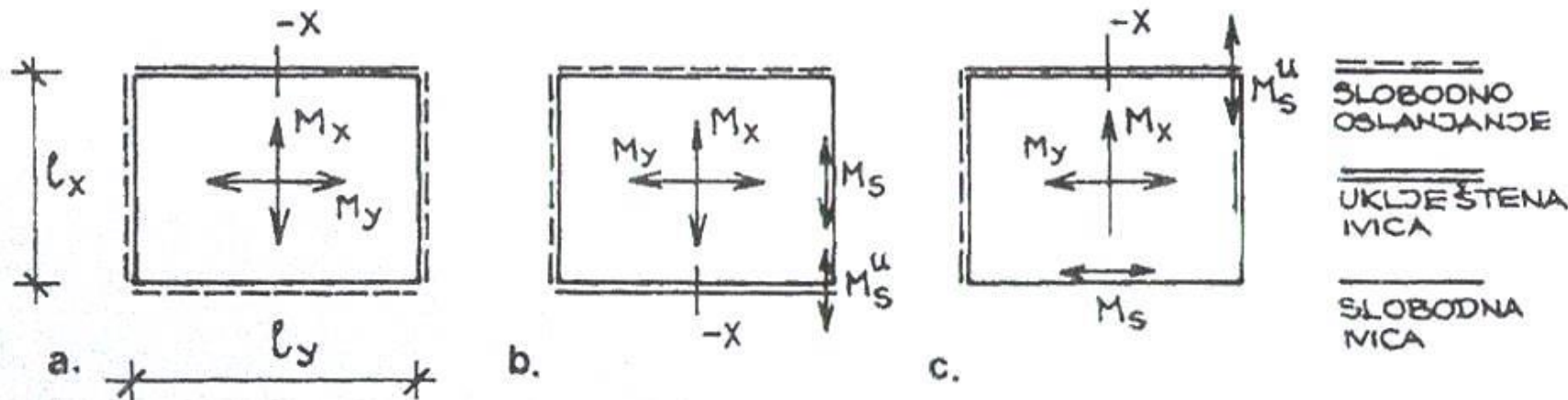

Slika 10.8 Primeri oslanjanja krstasto armiranih ploča

Primer 1

Ploča POS1, debljine $h_p=16$ cm oslonjena je na grede POS 2-6 (b/h=40/60 cm).

Pored sopstvene težine na ploču deluje dodatno stalno opterećenje $\Delta g=2.0$ kN/m² i promenljivo opterećenje $q=10.0$ kN/m².

Dimenzionisati ploču **POS1**, gredu **POS6** i stub **POS S6**.

C30/37
B500B
XC3

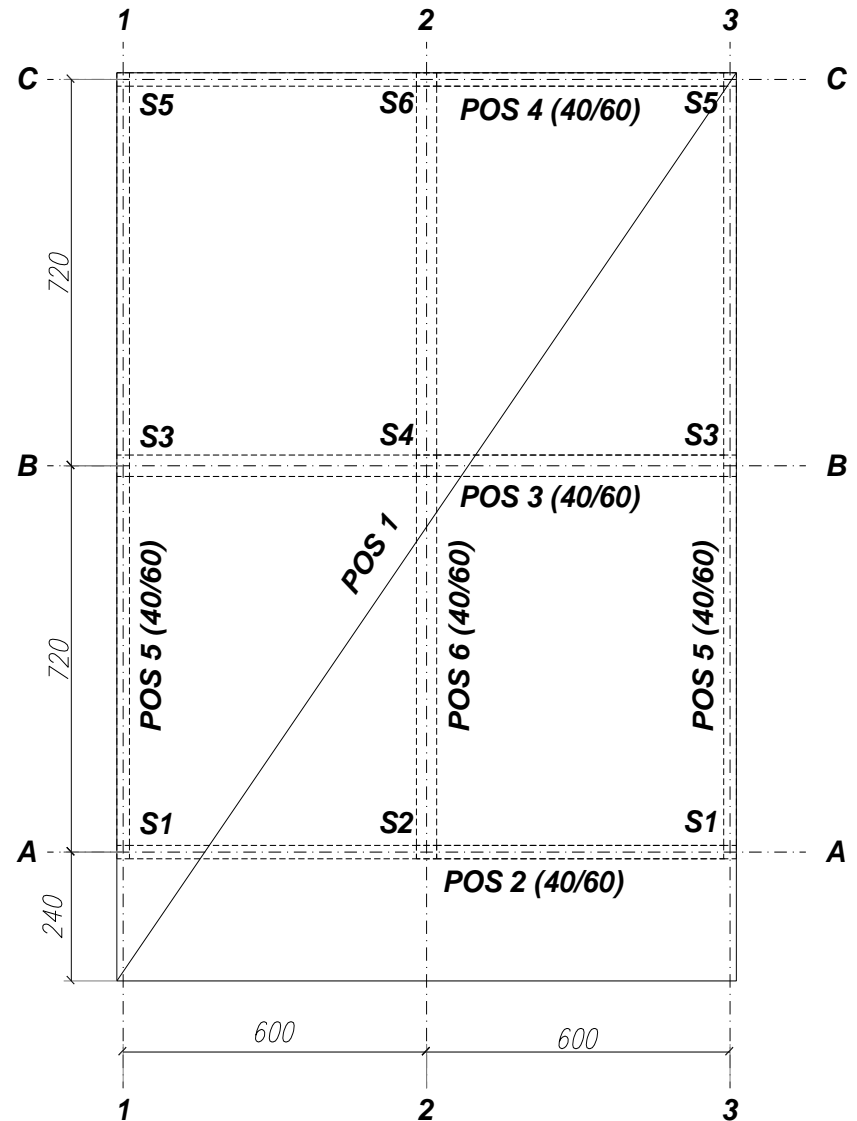

PLOČA POS 1

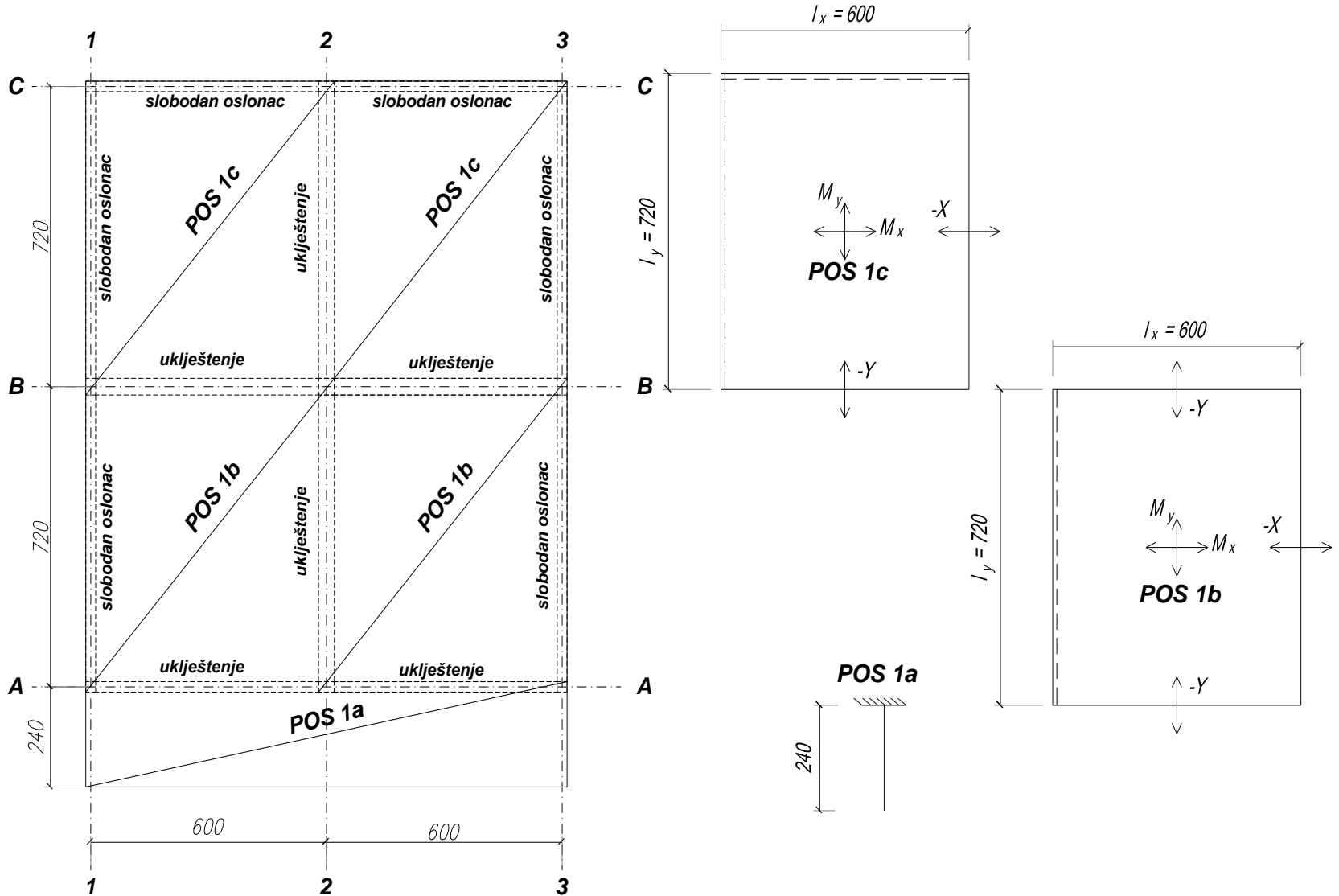

PLOČA POS 1 – Analiza opterećenja

1. Analiza opterećenja POS 1

Stalno opterećenje

sopstvena težina ploče

$$g_{st} = h_p \times \gamma_c = 0.16 \times 25.0 = 4.0 \text{ kN/m}^2$$

dodatno stalno opterećenje

$$\Delta g = 2.0 \text{ kN/m}^2$$

$$g = 6.0 \text{ kN/m}^2$$

promenljivo opterećenje

$$q = 10.0 \text{ kN/m}^2$$

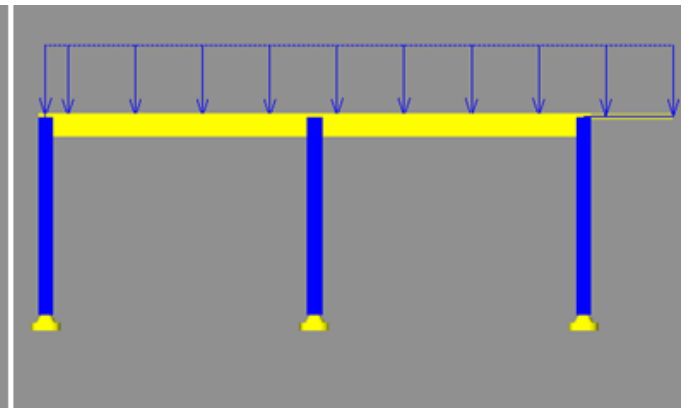
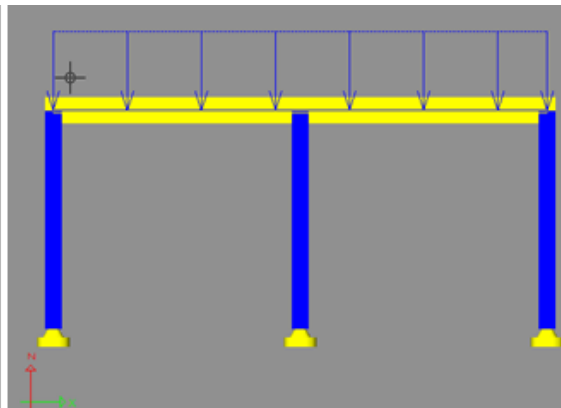
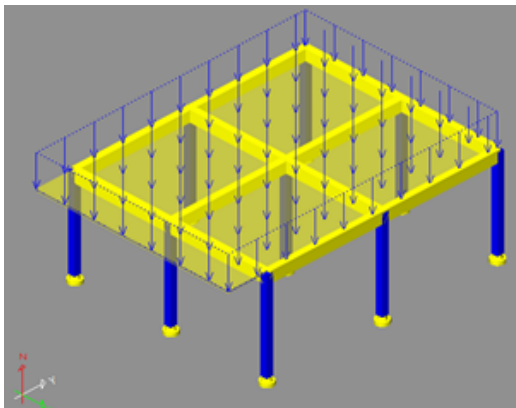

Statički uticaji - PLOČA POS 1a konzolna ploča

2.1. Statički sistem ploče POS 1a

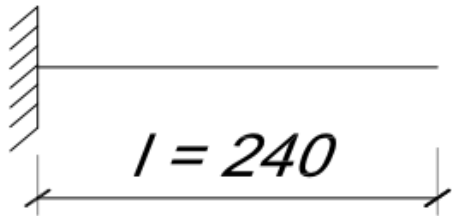

2.2. Statički uticaji u ploči POS1a

$$M_g = 6.0 \times \frac{2.4^2}{2} = 17.28 \text{ kNm/m}$$

$$M_q = 10.0 \times \frac{2.4^2}{2} = 28.80 \text{ kNm/m}$$

$$V_g = 6.0 \times 2.4 = 14.4 \text{ kN/m}$$

$$V_q = 10.0 \times 2.4 = 24.0 \text{ kN/m}$$

$$M_{Ed} = 1.35 \times 17.28 + 1.5 \times 28.8 = 66.53 \text{ kNm/m}$$

Statički uticaji - PLOČA POS 1b krstasta ploča

3.1. Statički sistem ploče POS1b

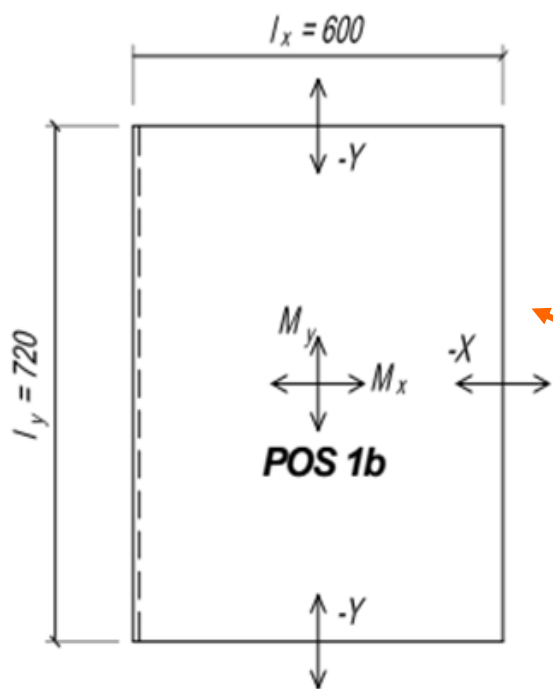

$$L_y/L_x = 7.2/6.0 = 1.20$$

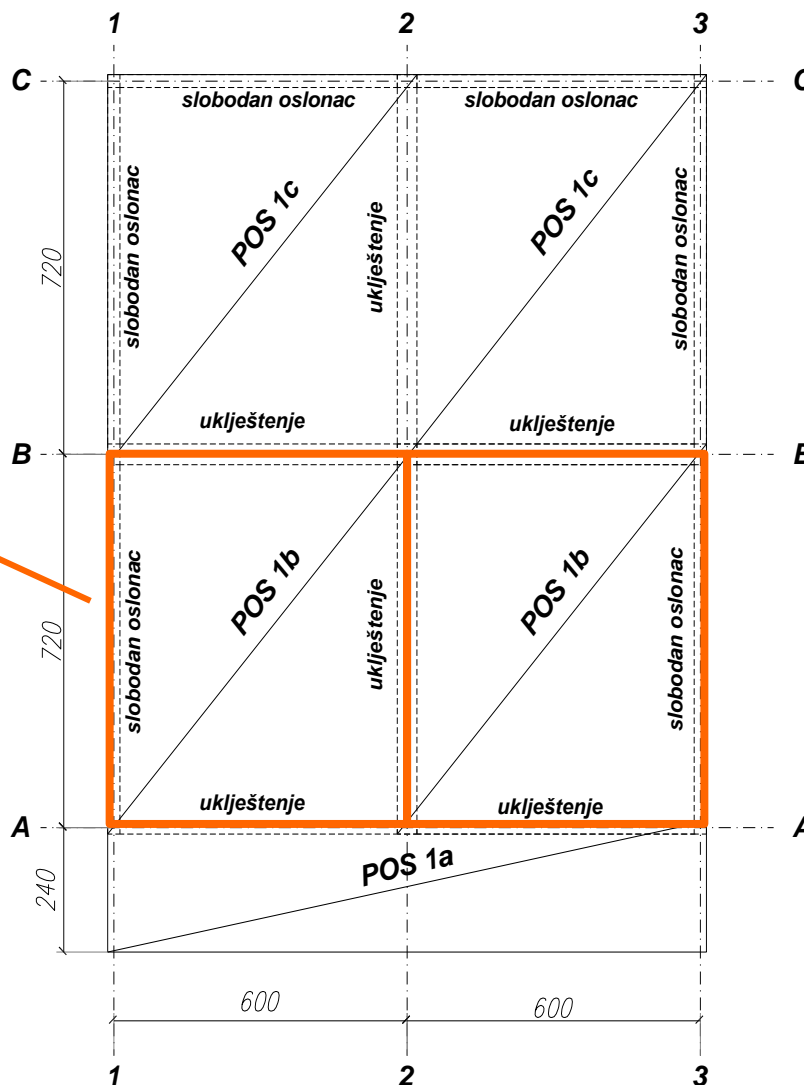

		$l_y:l_x$	1,0	1,1	1,2	1,3	1,4	1,5	1,6	1,7	1,8	1,9	2,0	
uključena ivica slobodna ostonjena ivica		Mx	0,044	0,047	0,049	0,051	0,052	0,052	0,053	0,052	0,052	0,052	0,051	0,050
		My	0,044	0,041	0,038	0,034	0,032	0,029	0,026	0,024	0,024	0,022	0,020	0,019
		Mx	0,021	0,023	0,023	0,024	0,020	0,020	0,023	0,022	0,022	0,022	0,021	0,021
		My	0,021	0,019	0,017	0,015	0,013	0,011	0,010	0,008	0,008	0,007	0,005	0,005
		-X	0,052	0,054	0,053	0,053	0,052	0,051	0,049	0,048	0,048	0,046	0,044	0,042
		-Y	0,052	0,049	0,047	0,044	0,041	0,038	0,036	0,034	0,034	0,032	0,030	0,029
		Mx	0,028	0,030	0,032	0,032	0,032	0,032	0,032	0,031	0,031	0,031	0,030	0,029
		My	0,028	0,025	0,023	0,021	0,019	0,017	0,014	0,014	0,014	0,012	0,011	0,010
		-X	0,068	0,070	0,071	0,071	0,070	0,069	0,067	0,065	0,065	0,063	0,061	0,059
		-Y	0,068	0,065	0,062	0,059	0,055	0,051	0,049	0,046	0,046	0,043	0,041	0,040
		Mx	0,022	0,025	0,028	0,032	0,035	0,037	0,039	0,040	0,041	0,041	0,042	0,043
		My	0,032	0,032	0,031	0,030	0,029	0,027	0,026	0,024	0,024	0,023	0,021	0,020
		-Y	0,070	0,072	0,073	0,072	0,072	0,070	0,068	0,066	0,066	0,064	0,062	0,060
		Hx	0,038	0,031	0,030	0,029	0,028	0,027	0,026	0,024	0,024	0,023	0,022	0,021
	My	0,022	0,018	0,015	0,013	0,011	0,009	0,008	0,007	0,007	0,006	0,005	0,005	
	-X	0,070	0,067	0,064	0,061	0,058	0,055	0,052	0,050	0,050	0,047	0,044	0,042	
	Mx	0,031	0,035	0,038	0,041	0,043	0,044	0,045	0,046	0,046	0,046	0,046	0,046	
	My	0,037	0,038	0,034	0,032	0,030	0,028	0,026	0,024	0,024	0,022	0,021	0,019	
	-Y	0,084	0,084	0,083	0,080	0,078	0,075	0,072	0,069	0,066	0,066	0,064	0,061	
	Mx	0,037	0,037	0,038	0,037	0,037	0,035	0,034	0,033	0,033	0,032	0,031	0,030	
	My	0,031	0,027	0,023	0,021	0,018	0,016	0,014	0,012	0,012	0,011	0,010	0,009	
	-X	0,084	0,084	0,082	0,079	0,077	0,074	0,071	0,069	0,069	0,066	0,063	0,061	
	Mx	0,021	0,022	0,026	0,028	0,029	0,029	0,029	0,029	0,029	0,028	0,028	0,028	
	My	0,025	0,022	0,023	0,022	0,019	0,017	0,016	0,014	0,014	0,012	0,011	0,011	
	-X	0,055	0,055	0,062	0,063	0,064	0,063	0,062	0,061	0,061	0,059	0,058	0,057	
	-Y	0,040	0,037	0,058	0,055	0,053	0,051	0,048	0,046	0,046	0,043	0,041	0,039	
	Mx	0,026	0,028	0,027	0,027	0,026	0,025	0,024	0,024	0,024	0,022	0,022	0,021	
	My	0,021	0,018	0,016	0,014	0,012	0,010	0,009	0,008	0,008	0,007	0,006	0,006	
	-X	0,060	0,060	0,059	0,057	0,055	0,053	0,050	0,048	0,048	0,046	0,044	0,042	
	-Y	0,055	0,052	0,048	0,044	0,041	0,038	0,036	0,034	0,034	0,032	0,030	0,029	

P
 q, l, l_x (kN)
 M
 k, P (kNm/m)



Statički uticaji - PLOČA POS 1b krstasta ploča

3.2. Statički uticaji u ploči POS1b

$$L_y/L_x = 7.2/6.0 = 1.20$$

$$G = 6.0 \times 7.2 \times 6.0 = 259.2 \text{ kN}$$

$$Q = 10.0 \times 7.2 \times 6.0 = 432 \text{ kN}$$

$$F_{Ed} = 1.35 \times 259.2 + 1.5 \times 432 = 997.92 \text{ kN}$$

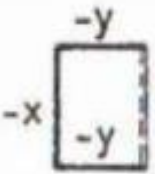
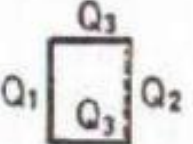
	$l_y : l_x$	1,2
	Mx	0,026
	My	0,023
	-X	0,062
	-Y	0,058
	Q1	0,300
	Q2	0,210
	Q3	0,245

Proračunska vrednost momenata savijanja

$$M_{x,Ed} = F_{Ed} \times 0.026 = 997.92 \times 0.026 = 25.95 \text{ kNm/m}$$

$$M_{y,Ed} = F_{Ed} \times 0.023 = 997.92 \times 0.023 = 22.95 \text{ kNm/m}$$

$$X_{Ed} = F_{Ed} \times 0.062 = 997.92 \times 0.062 = 61.87 \text{ kNm/m}$$

$$Y_{Ed} = F_{Ed} \times 0.058 = 997.92 \times 0.058 = 57.88 \text{ kNm/m}$$

Koeficijenti r_j za određivanje rezultante reakcije oslonca krstasto armirane ploče, oslonjene na sve četiri strane, opterećenih jednako podjeljenim opterećenjem q (kN/m²)

$$P = q l_x l_y \quad (kN) \quad Q = r_j P \quad (kN)$$

$l_y : l_x$		1,0	1,1	1,2	1,3	1,4	1,5	1,6	1,7	1,8	1,9	2,0
	Q ₁	0,250	0,260	0,272	0,280	0,288	0,296	0,304	0,310	0,316	0,322	0,327
	Q ₂	0,250	0,240	0,228	0,220	0,212	0,204	0,196	0,190	0,184	0,178	0,173
	Q ₁	0,220	0,232	0,244	0,254	0,264	0,273	0,281	0,290	0,296	0,302	0,308
	Q ₂	0,330	0,313	0,298	0,285	0,272	0,262	0,251	0,242	0,234	0,227	0,220
	Q ₃	0,230	0,223	0,214	0,207	0,200	0,192	0,187	0,178	0,174	0,169	0,164
	Q ₁	0,330	0,346	0,362	0,376	0,387	0,399	0,410	0,418	0,426	0,434	0,442
	Q ₂	0,230	0,240	0,246	0,252	0,257	0,261	0,264	0,270	0,274	0,276	0,278
	Q ₃	0,220	0,207	0,196	0,186	0,178	0,170	0,163	0,156	0,150	0,145	0,140
	Q ₁	0,198	0,211	0,223	0,234	0,244	0,254	0,262	0,270	0,278	0,285	0,292
	Q ₂	0,302	0,289	0,277	0,266	0,256	0,246	0,238	0,230	0,222	0,215	0,208
	Q ₁	0,302	0,315	0,326	0,334	0,342	0,350	0,356	0,361	0,367	0,372	0,377
	Q ₂	0,198	0,185	0,174	0,166	0,158	0,150	0,144	0,139	0,133	0,128	0,123
	Q ₁	0,292	0,313	0,331	0,346	0,360	0,370	0,380	0,390	0,400	0,410	0,419
	Q ₂	0,208	0,217	0,226	0,233	0,241	0,247	0,252	0,256	0,260	0,263	0,266
	Q ₃	0,292	0,274	0,257	0,244	0,230	0,221	0,212	0,204	0,196	0,189	0,182
	Q ₄	0,208	0,196	0,186	0,177	0,169	0,162	0,156	0,150	0,144	0,138	0,133
	Q ₁	0,262	0,280	0,300	0,316	0,329	0,344	0,354	0,365	0,376	0,386	0,394
	Q ₂	0,198	0,208	0,210	0,218	0,227	0,234	0,240	0,245	0,250	0,254	0,258
	Q ₃	0,274	0,254	0,245	0,233	0,222	0,211	0,203	0,195	0,187	0,180	0,174
	Q ₁	0,274	0,285	0,297	0,309	0,318	0,326	0,334	0,341	0,347	0,353	0,358
	Q ₂	0,190	0,182	0,174	0,165	0,158	0,152	0,146	0,141	0,136	0,131	0,126
	Q ₃	0,262	0,248	0,232	0,217	0,206	0,196	0,186	0,177	0,170	0,163	0,158
	Q ₁	0,250	0,266	0,279	0,291	0,302	0,312	0,320	0,327	0,333	0,339	0,345
	Q ₂	0,250	0,234	0,221	0,209	0,198	0,188	0,180	0,173	0,167	0,161	0,155

Približno opterećenje oslončke grede

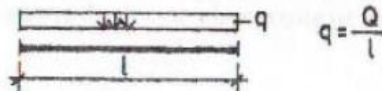

— uključena ivica
- - - - - slobodno oslonjena ivica

Statički uticaji - PLOČA POS 1b krstasta ploča

3.2. Statički uticaji u ploči POS1b

Reakcije ploče POS1b

$$R_{1,g} = G \times 0.300 = 259.2 \times 0.300 = 77.76 \text{ kN}$$

$$R_{2,g} = G \times 0.210 = 259.2 \times 0.210 = 54.43 \text{ kN}$$

$$R_{3,g} = G \times 0.245 = 259.2 \times 0.245 = 63.50 \text{ kN}$$

$$R_{1,q} = Q \times 0.300 = 432 \times 0.300 = 129.6 \text{ kN}$$

$$R_{2,q} = Q \times 0.210 = 432 \times 0.210 = 90.70 \text{ kN}$$

$$R_{3,q} = Q \times 0.245 = 432 \times 0.245 = 105.80 \text{ kN}$$

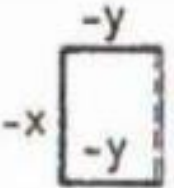
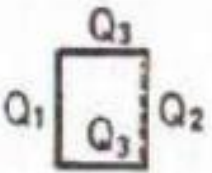
	$l_y : l_x$	1,2
	M_x	0,026
	M_y	0,023
	$-X$	0,062
	$-Y$	0,058
	Q_1	0,300
	Q_2	0,210
	Q_3	0,245

Statički uticaji - PLOČA POS 1c krstasta ploča

4.1. Statički sistem ploče POS1c

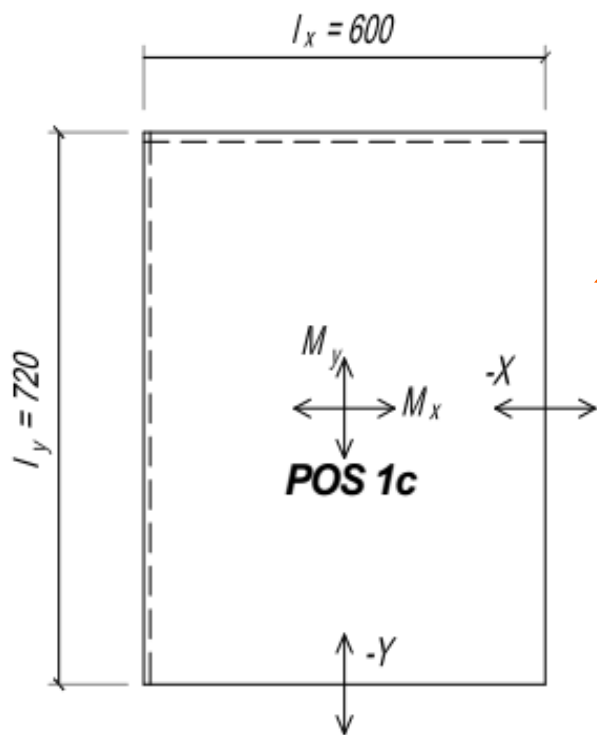

$$L_y/L_x = 7.2/6.0 = 1.20$$

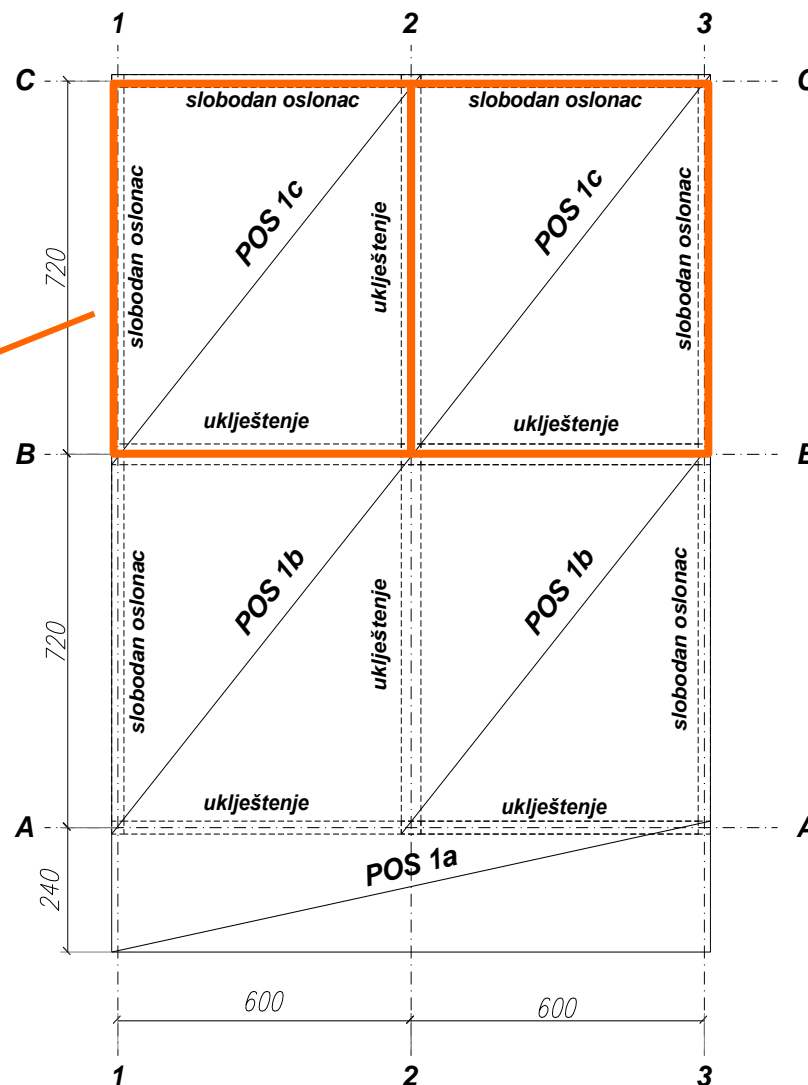

		$l_y:l_x$	1,0	1,1	1,2	1,3	1,4	1,5	1,6	1,7	1,8	1,9	2,0	
uključena ivica		M_x	0,044	0,047	0,049	0,051	0,052	0,052	0,053	0,052	0,052	0,051	0,050	
		M_y	0,044	0,041	0,038	0,034	0,032	0,029	0,026	0,024	0,022	0,020	0,019	
		$-X$	0,021	0,023	0,023	0,024	0,020	0,020	0,023	0,022	0,022	0,021	0,021	
		$-Y$	0,021	0,019	0,017	0,015	0,013	0,011	0,010	0,008	0,007	0,005	0,005	
	slobodna ostonjena ivica		M_x	0,028	0,030	0,032	0,032	0,032	0,032	0,032	0,031	0,031	0,030	0,029
			M_y	0,028	0,025	0,023	0,021	0,019	0,017	0,014	0,014	0,012	0,011	0,010
			$-X$	0,066	0,071	0,071	0,070	0,069	0,067	0,065	0,063	0,061	0,059	0,059
			$-Y$	0,066	0,061	0,062	0,059	0,055	0,051	0,049	0,046	0,043	0,041	0,040
			M_x	0,022	0,025	0,028	0,032	0,035	0,037	0,039	0,040	0,041	0,042	0,043
			M_y	0,032	0,032	0,031	0,030	0,029	0,027	0,026	0,024	0,023	0,021	0,020
			$-Y$	0,070	0,072	0,073	0,072	0,072	0,070	0,068	0,066	0,064	0,062	0,060
			M_x	0,032	0,031	0,030	0,029	0,028	0,027	0,026	0,024	0,023	0,022	0,021
			M_y	0,022	0,018	0,015	0,013	0,011	0,009	0,008	0,007	0,006	0,005	0,005
		$-X$	0,070	0,067	0,064	0,061	0,058	0,055	0,052	0,050	0,047	0,044	0,042	
		M_x	0,031	0,035	0,038	0,041	0,043	0,044	0,045	0,046	0,046	0,046	0,046	
		M_y	0,037	0,038	0,034	0,032	0,030	0,028	0,026	0,024	0,022	0,021	0,019	
		$-Y$	0,084	0,084	0,083	0,080	0,078	0,075	0,072	0,069	0,066	0,064	0,061	
	M_x	0,037	0,037	0,038	0,037	0,037	0,035	0,034	0,033	0,032	0,031	0,030		
	M_y	0,031	0,027	0,023	0,021	0,018	0,016	0,014	0,012	0,011	0,010	0,009		
	$-X$	0,084	0,084	0,082	0,079	0,077	0,074	0,071	0,069	0,066	0,063	0,061		
	M_x	0,021	0,024	0,026	0,028	0,029	0,029	0,029	0,029	0,028	0,028	0,028		
	M_y	0,026	0,025	0,023	0,022	0,019	0,017	0,016	0,014	0,012	0,011	0,011		
	$-X$	0,055	0,059	0,062	0,063	0,064	0,063	0,062	0,061	0,059	0,058	0,057		
	$-Y$	0,050	0,059	0,058	0,055	0,053	0,051	0,048	0,046	0,043	0,041	0,039		
	M_x	0,026	0,025	0,027	0,027	0,026	0,025	0,024	0,024	0,022	0,022	0,021		
	M_y	0,021	0,018	0,016	0,014	0,012	0,010	0,009	0,008	0,007	0,006	0,006		
	$-X$	0,060	0,060	0,059	0,057	0,055	0,053	0,050	0,048	0,046	0,044	0,042		
	$-Y$	0,055	0,052	0,048	0,044	0,041	0,038	0,036	0,034	0,032	0,030	0,029		

P
 q, l_x, l_y (kN)
 M
 k, P (kNm/m)



Statički uticaji - PLOČA POS 1c krstasta ploča

4.2. Statički uticaji u ploči POS1c

$$L_y/L_x = 7.2/6.0 = 1.20$$

$$G = 6.0 \times 7.2 \times 6.0 = 259.2 \text{ kN}$$

$$Q = 10.0 \times 7.2 \times 6.0 = 432 \text{ kN}$$

$$F_{Ed} = 1.35 \times 259.2 + 1.5 \times 432 = 997.92 \text{ kN}$$

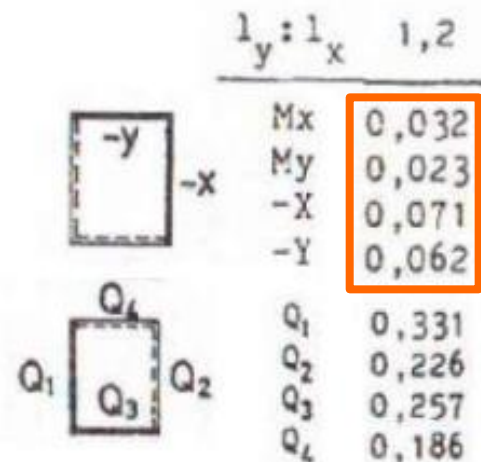

The diagram shows a square slab with a coordinate system where the origin is at the top-left corner. The horizontal axis is labeled '-x' and the vertical axis is labeled '-y'. Below the slab, four corner loads are indicated: Q1 at the top-left, Q2 at the top-right, Q3 at the bottom-left, and Q4 at the bottom-right. To the right of the diagram is a table of influence coefficients.

	$l_y : l_x$	1,2
Mx		0,032
My		0,023
-X		0,071
-Y		0,062
Q1		0,331
Q2		0,226
Q3		0,257
Q4		0,186

Proračunska vrednost momenata savijanja

$$M_{x,Ed} = F_{Ed} \times 0.032 = 997.92 \times 0.032 = 31.93 \text{ kNm/m}$$

$$M_{y,Ed} = F_{Ed} \times 0.023 = 997.92 \times 0.023 = 22.95 \text{ kNm/m}$$

$$X_{Ed} = F_{Ed} \times 0.071 = 997.92 \times 0.071 = 70.85 \text{ kNm/m}$$

$$Y_{Ed} = F_{Ed} \times 0.062 = 997.92 \times 0.062 = 61.87 \text{ kNm/m}$$

Koeficijenti r_j za određivanje rezultante reakcije oslonca krstasto armirane ploče, oslonjene na sve četiri strane, opterećenih jednako podjeljenim opterećenjem q (kN/m²)

$$P = q l_x l_y \quad (kN)$$

$$Q = r_j P \quad (kN)$$

$l_y : l_x$		1,0	1,1	1,2	1,3	1,4	1,5	1,6	1,7	1,8	1,9	2,0
	Q ₁	0,250	0,260	0,272	0,280	0,288	0,296	0,304	0,310	0,316	0,322	0,327
	Q ₂	0,250	0,240	0,228	0,220	0,212	0,204	0,196	0,190	0,184	0,178	0,173
	Q ₁	0,220	0,232	0,244	0,254	0,264	0,273	0,281	0,290	0,296	0,302	0,308
	Q ₂	0,330	0,313	0,298	0,285	0,272	0,262	0,251	0,242	0,234	0,227	0,220
	Q ₃	0,230	0,223	0,214	0,207	0,200	0,192	0,187	0,178	0,174	0,169	0,164
	Q ₁	0,330	0,346	0,362	0,376	0,387	0,399	0,410	0,418	0,426	0,434	0,442
	Q ₂	0,230	0,240	0,246	0,252	0,257	0,261	0,264	0,270	0,274	0,276	0,278
	Q ₃	0,220	0,207	0,196	0,186	0,178	0,170	0,163	0,156	0,150	0,145	0,140
	Q ₁	0,198	0,211	0,223	0,234	0,244	0,254	0,262	0,270	0,278	0,285	0,292
	Q ₂	0,302	0,289	0,277	0,266	0,256	0,246	0,238	0,230	0,222	0,215	0,208
	Q ₁	0,302	0,315	0,326	0,334	0,342	0,350	0,356	0,361	0,367	0,372	0,377
	Q ₂	0,198	0,185	0,174	0,166	0,158	0,150	0,144	0,139	0,133	0,128	0,123
	Q ₁	0,292	0,315	0,331	0,346	0,360	0,370	0,380	0,390	0,400	0,410	0,419
	Q ₂	0,298	0,275	0,266	0,253	0,241	0,247	0,252	0,256	0,260	0,263	0,266
	Q ₃	0,292	0,275	0,257	0,244	0,230	0,221	0,212	0,204	0,196	0,189	0,182
	Q ₄	0,208	0,196	0,186	0,177	0,169	0,162	0,156	0,150	0,144	0,138	0,133
	Q ₁	0,262	0,282	0,300	0,316	0,329	0,344	0,354	0,365	0,376	0,386	0,394
	Q ₂	0,190	0,200	0,210	0,218	0,227	0,234	0,240	0,245	0,250	0,254	0,258
	Q ₃	0,274	0,259	0,245	0,233	0,222	0,211	0,203	0,195	0,187	0,180	0,174
	Q ₁	0,274	0,285	0,297	0,309	0,318	0,326	0,334	0,341	0,347	0,353	0,358
	Q ₂	0,190	0,182	0,174	0,165	0,158	0,152	0,146	0,141	0,136	0,131	0,126
	Q ₃	0,262	0,248	0,232	0,217	0,206	0,196	0,186	0,177	0,170	0,163	0,158
	Q ₁	0,250	0,266	0,279	0,291	0,302	0,312	0,320	0,327	0,333	0,339	0,345
	Q ₂	0,250	0,234	0,221	0,209	0,198	0,188	0,180	0,173	0,167	0,161	0,155

— uključena ivica
 - - - - - slobodno oslonjena ivica

Približno opterećenje oslončke grede

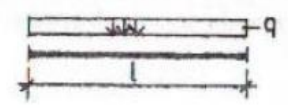

$$q = \frac{Q}{l}$$



Statički uticaji - PLOČA POS 1c krstasta ploča

4.2. Statički uticaji u ploči POS1c

$$R_{1,g} = G \times 0.331 = 259.2 \times 0.331 = 85.80 \text{ kN}$$

$$R_{2,g} = G \times 0.226 = 259.2 \times 0.226 = 58.58 \text{ kN}$$

$$R_{3,g} = G \times 0.257 = 259.2 \times 0.257 = 66.61 \text{ kN}$$

$$R_{4,g} = G \times 0.186 = 259.2 \times 0.186 = 48.21 \text{ kN}$$

$$R_{1,q} = Q \times 0.331 = 432 \times 0.331 = 143.00 \text{ kN}$$

$$R_{2,q} = Q \times 0.226 = 432 \times 0.226 = 97.63 \text{ kN}$$

$$R_{3,q} = Q \times 0.257 = 432 \times 0.257 = 111.02 \text{ kN}$$

$$R_{4,q} = Q \times 0.186 = 432 \times 0.186 = 80.35 \text{ kN}$$

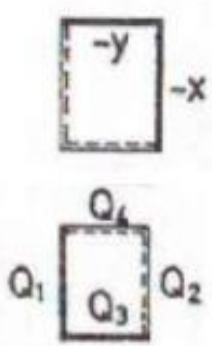

The diagram shows a square cross-section with a dashed outline. The top-left corner is labeled '-y' and the top-right corner is labeled '-x'. Below the square, four load points are indicated: Q1 at the top, Q2 at the right, Q3 at the bottom, and Q4 at the left.

	$l_y : l_x$	1,2
Mx		0,032
My		0,023
-X		0,071
-Y		0,062
Q1		0,331
Q2		0,226
Q3		0,257
Q4		0,186

Statički uticaji PLOČA POS 1

1-1
Med,x

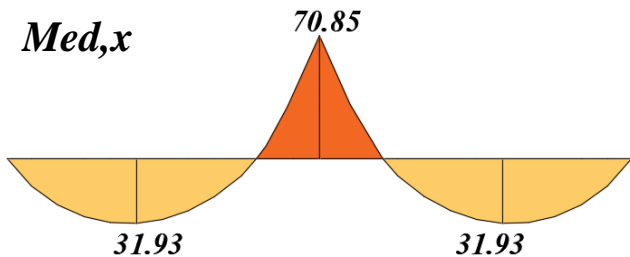

2-2
Med,x

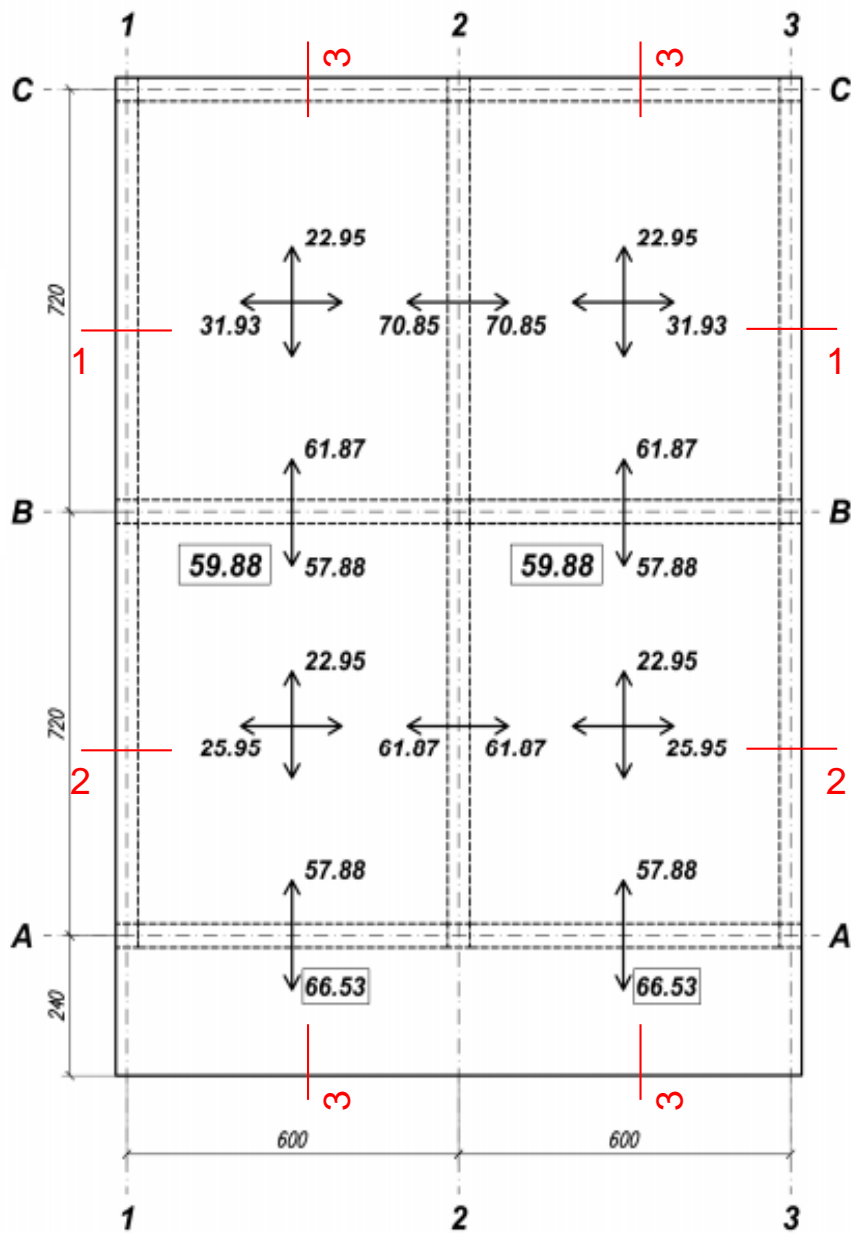
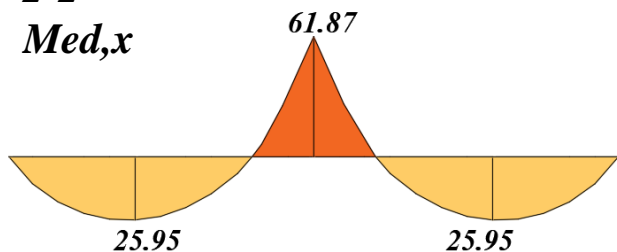

3-3
Med,y

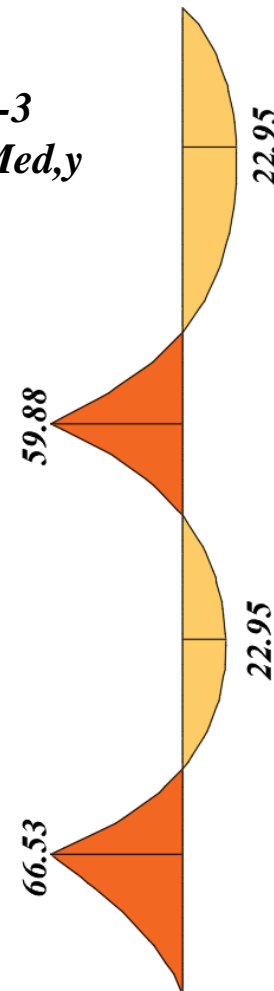

Dimenzionisanje ploče

$$C30/37 \rightarrow f_{cd} = 0.85 \times \frac{30}{1.5 \times 10} = 1.7 \text{ kN/cm}^2$$

$$B500B \rightarrow f_{yd} = \frac{500}{1.15 \times 10} = 43.5 \text{ kN/cm}^2$$

$$XC3 \rightarrow C_{nom} = 3.0 \text{ cm}$$

$$k = \frac{d}{\sqrt{\frac{M_{Ed}}{b \times f_{cd}}}} = \frac{d}{\sqrt{\frac{M_{Ed}}{100 \times f_{cd}}}} \rightarrow \text{Tablice} \rightarrow \omega_1$$

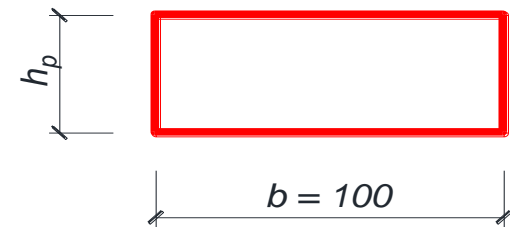

$$A_{s1} = \omega_1 \times \frac{b \times d}{100} \times \frac{f_{cd}}{f_{yd}} = \omega_1 \times d \times \frac{f_{cd}}{f_{yd}}$$

Dimenzionisanje ploče

5.1. Gornja zona - kraći pravac

5.1.1. $X_{Ed} = 70.85 \text{ kNm/m}$

pret. $d_{1,x} = 4 \text{ cm}$ ($C_{nom} = 3 \text{ cm}$)

$d_x = 16 - 4 = 12 \text{ cm}$; $b = 100 \text{ cm}$

$$k = \frac{12}{\sqrt{\frac{70.85}{1.7}}} = 1.859$$

$\varepsilon_c/\varepsilon_s = 3.5/4.5 \text{ ‰}$; $\omega_1 = 35.417 \text{ ‰}$

$$A_s = 35.417 \times 12 \times \frac{1.7}{43.5} = 16.6 \text{ cm}^2 / \text{m}$$

pret. $\emptyset 16$ ($a_s = 2.01 \text{ cm}^2$) $\rightarrow s = \frac{100 \times 2.01}{16.6} = 12.11 \text{ cm}$

usvojeno: $\emptyset 16/10$ ($A_{s,usv} = \frac{100 \times 2.01}{10} = 20.1 \text{ cm}^2 / \text{m}$)

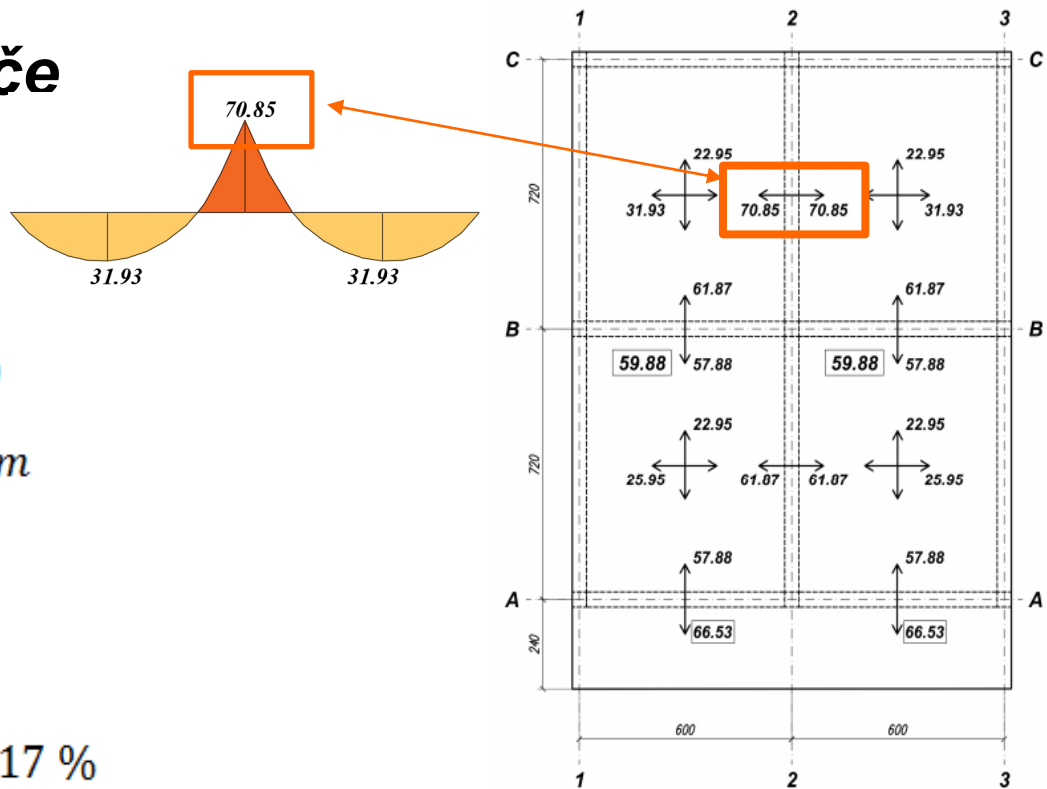

Dimenzionisanje ploče

$$d_{1,x} = 3.0 + \frac{1.6}{2} = 3.8 \text{ cm} \rightarrow d_{x,stv} = 16 - 3.8 = 12.2 \text{ cm} > d_{pret} = 12 \text{ cm}$$

$$A_{sp} = 0.2 \times 16.6 = 3.32 \text{ cm}^2/m$$

$$pret. \emptyset 10 (a_s = 0.785 \text{ cm}^2) \rightarrow s = \frac{100 \times 0.785}{3.32} = 23.64 \text{ cm}$$

usvojeno: $\emptyset 10/20$ ($3.93 \text{ cm}^2/m$)

$$s_{\max,slabs} = \min \left\{ \begin{array}{l} 2 \cdot 16 = 32 \text{ cm} \\ 25 \text{ cm} \end{array} \right\} = 25 \text{ cm}$$

$$s_{p,\max,slabs} = \min \left\{ \begin{array}{l} 3 \cdot 16 = 48 \text{ cm} \\ 40 \text{ cm} \end{array} \right\} = 40 \text{ cm}$$

Dimenzionisanje ploče

5.1.2. $X_{Ed} = 61.87 \text{ kNm/m}$

$$k = \frac{12}{\sqrt{\frac{61.87}{1.7}}} = 1.989$$

$$\varepsilon_c / \varepsilon_s = 3.5 / 6.0 \text{ ‰} ; \omega_1 = 29.825 \text{ ‰}$$

$$A_s = 29.825 \times 12 \times \frac{1.7}{43.5} = 14.06 \text{ cm}^2 / \text{m}$$

$$\text{pret. } \emptyset 16 (a_s = 2.01 \text{ cm}^2) \rightarrow s = \frac{100 \times 2.01}{14.06} = 14.3 \text{ cm}$$

$$\text{usvojeno: } \emptyset 16 / 12.5 (A_{s,usv} = \frac{100 \times 2.01}{12.5} = 16.08 \text{ cm}^2 / \text{m})$$

$$A_{sp} = 0.2 \times 14.06 = 2.81 \text{ cm}^2 / \text{m}$$

$$\text{pret. } \emptyset 10 (a_s = 0.785 \text{ cm}^2) \rightarrow s = \frac{100 \times 0.785}{2.81} = 27.92 \text{ cm}$$

$$\text{usvojeno: } \emptyset 10 / 25 (3.14 \text{ cm}^2 / \text{m})$$

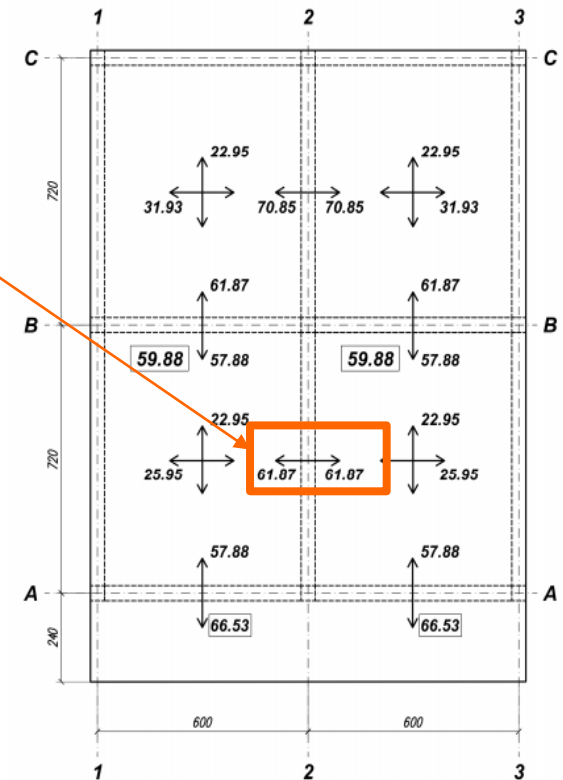
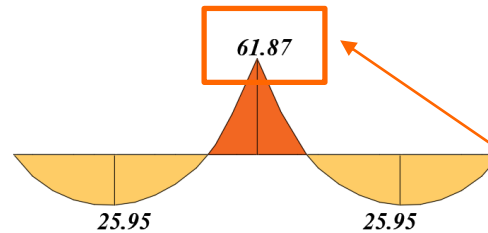

Dimenzionisanje ploče

5.2. Gornja zona - duži pravac

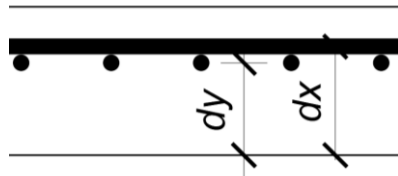

5.2.1. $Y_{Ed} = 66.53 \text{ kNm/m}$

pret. $d_{1,y} = 5.4 \text{ cm} (= d_{1,y} + \varnothing = 3.8 + 1.6)$

$d_y = 16 - 5.4 = 10.6 \text{ cm}; b = 100 \text{ cm}$

$$k = \frac{10.6}{\sqrt{\frac{66.53}{1.7}}} = 1.694$$

$\varepsilon_c / \varepsilon_s = 3.5 / 2.75 \text{ ‰}; \omega_1 = 45.333\%$

$$A_s = 45.333 \times 10.6 \times \frac{1.7}{43.5} = 18.8 \text{ cm}^2/\text{m}$$

pret. 16 ($a_s = 2.01 \text{ cm}^2$) $\rightarrow s = \frac{100 \times 2.01}{18.8} = 10.70 \text{ cm}$

usvojeno: $\varnothing 16/10$ ($A_{s,usv} = \frac{100 \times 2.01}{10} = 20.1 \text{ cm}^2/\text{m}$)

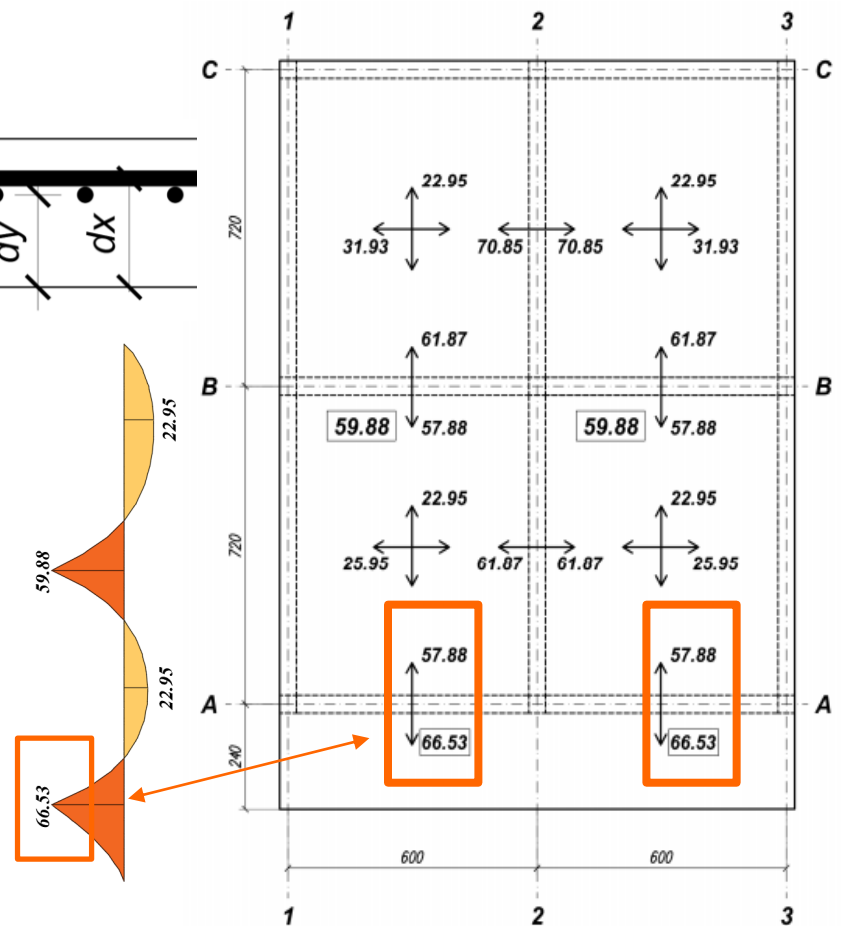



Dimenzionisanje ploče

$$d_{1,y} = 3.0 + 1.6 + \frac{1.6}{2} = 5.4 \text{ cm} \rightarrow d_{y,stv} = d_{pret} = 10.6 \text{ cm}$$

$$A_{sp} = 0.2 \times 18.9 = 3.78 \text{ cm}^2/m$$

$$pret. \text{ } \emptyset 10 (a_s = 0.785 \text{ cm}^2) \rightarrow s = \frac{100 \times 0.785}{3.78} = 20.77 \text{ cm}$$

usvojeno: $\emptyset 10/20$ ($3.93 \text{ cm}^2/m$)

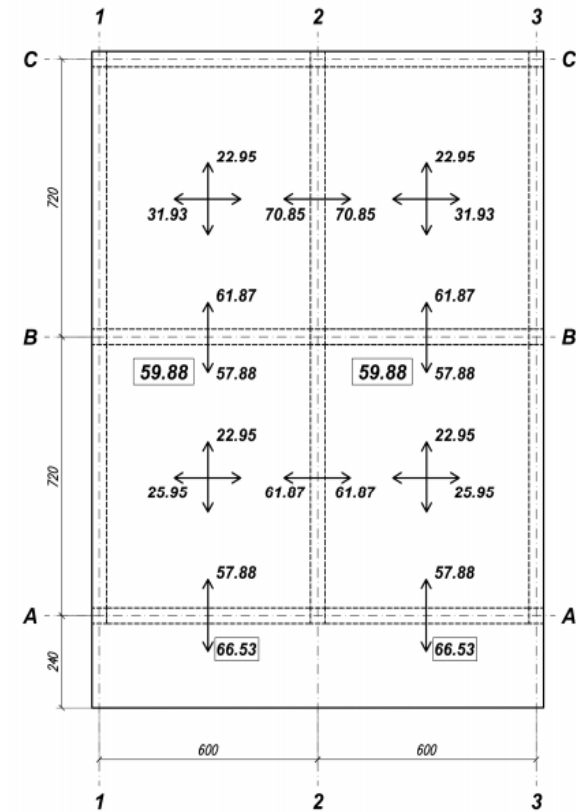

Dimenzionisanje ploče

5.2.2. $Y_{Ed} = 59.88 \text{ kNm/m}$

$$k = \frac{10.6}{\sqrt{\frac{59.88}{1.7}}} = 1.786$$

$$\varepsilon_c / \varepsilon_s = 3.5 / 3.7 \text{ ‰} ; \omega_1 = 39.352\%$$

$$A_s = 39.352 \times 10.6 \times \frac{1.7}{43.5} = 16.30 \text{ cm}^2/\text{m}$$

$$\text{pret. } 16 (a_s = 2.01 \text{ cm}^2) \rightarrow s = \frac{100 \times 2.01}{16.30} = 12.33 \text{ cm}$$

$$\text{usvojeno: } \varnothing 16/10 (A_{s,usv} = \frac{100 \times 2.01}{10} = 20.1 \text{ cm}^2/\text{m})$$

$$A_{sp} = 0.2 \times 16.29 = 3.26 \text{ cm}^2/\text{m}$$

$$\text{pret. } 10 (a_s = 0.785 \text{ cm}^2) \rightarrow s = \frac{100 \times 0.785}{3.26} = 24.08 \text{ cm}$$

$$\text{usvojeno: } \varnothing 10/20 (3.93 \text{ cm}^2/\text{m})$$

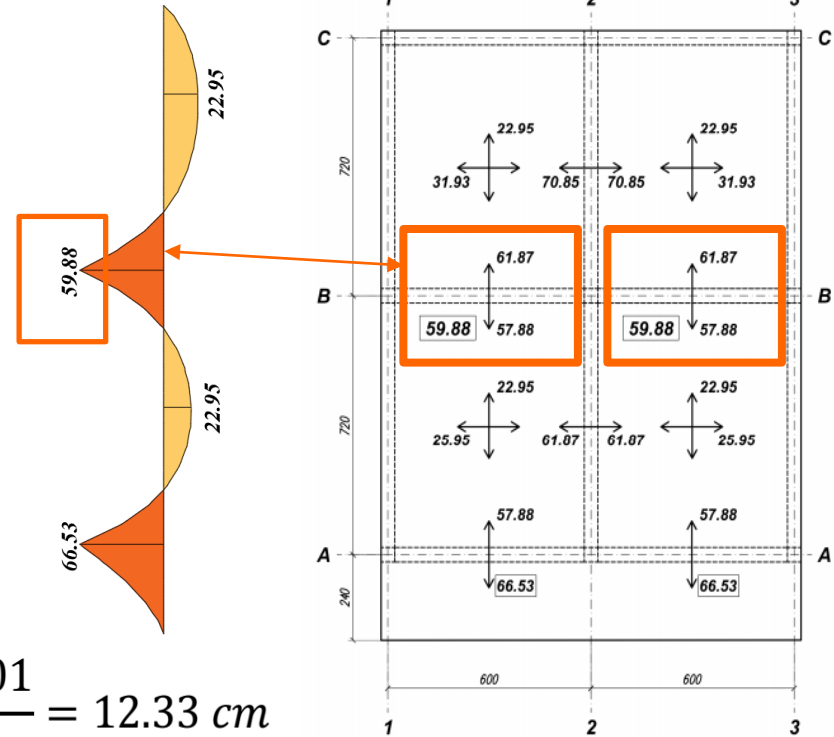

Dimenzionisanje ploče

5.3. Donja zona - kraći pravac

5.3.1. $M_{x,Ed} = 31.93 \text{ kNm/m}$

pret. $d_{1,x} = 3.5 \text{ cm} (= 3.0 + 1.0/2)$

$d_x = 16 - 3.5 = 12.5 \text{ cm}; b = 100 \text{ cm}$

$$k = \frac{12.5}{\sqrt{\frac{31.93}{1.7}}} = 2.884$$

$\varepsilon_c/\varepsilon_s = 3.5/18.5 \text{ ‰}; \omega_1 = 12.879 \text{ ‰}$

$$A_s = 12.879 \times 12.5 \times \frac{1.7}{43.5} = 6.29 \text{ cm}^2/\text{m}$$

$A_{s,min} = 0.15 \times 12.5 = 1.88 \text{ cm}^2/\text{m}$

pret. $\emptyset 10 (a_s = 0.785 \text{ cm}^2) \rightarrow s = \frac{100 \times 0.785}{6.29} = 12.48 \text{ cm}$

usvojeno: $\emptyset 10/10 (A_{s,usv} = 7.85 \text{ cm}^2/\text{m})$

$d_{1,x} = 3.0 + \frac{1.0}{2} = 3.5 \text{ cm} \rightarrow d_{x,stv} = d_{x,pret} = 12.5 \text{ cm}$

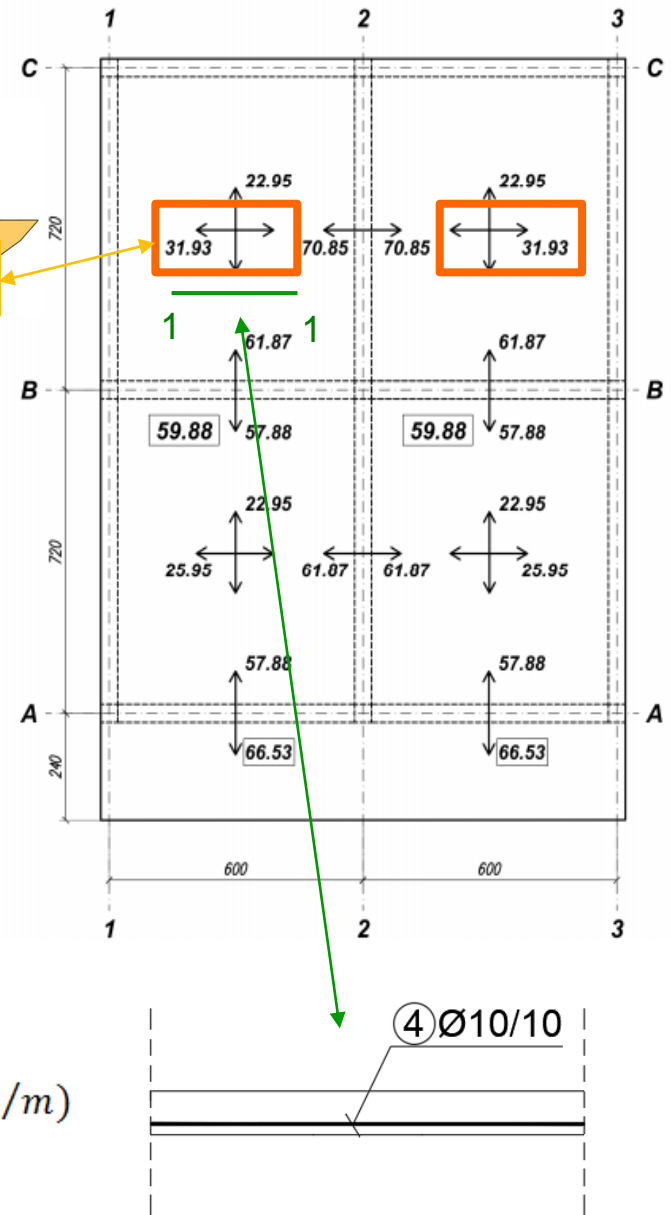
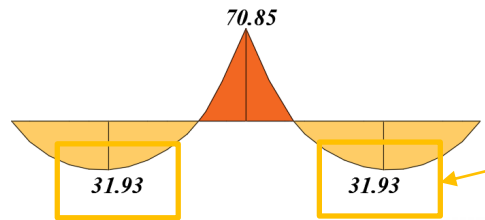

Dimenzionisanje ploče

5.3.2. $M_{x,Ed} = 25.95 \text{ kNm/m}$

$$k = \frac{12.5}{\sqrt{\frac{25.95}{1.7}}} = 3.199$$

$$\varepsilon_c / \varepsilon_s = 3.5 / 24 \text{ ‰} ; \omega_1 = 10.303 \%$$

$$A_s = 10.303 \times 12.5 \times \frac{1.7}{43.5} = 5.05 \text{ cm}^2 / \text{m}$$

$$\text{pret. } \emptyset 10 \text{ (} a_s = 0.785 \text{ cm}^2 \text{)} \rightarrow s = \frac{100 \times 0.785}{5.05} = 15.55 \text{ cm}$$

$$\text{usvojeno: } \emptyset 10 / 15 \text{ (} A_{s,usv} = 5.23 \text{ cm}^2 / \text{m)}$$

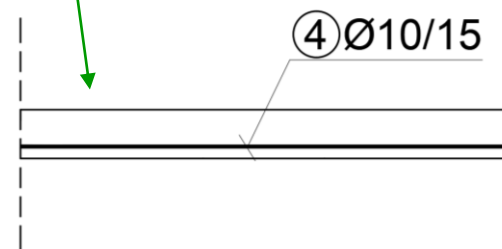
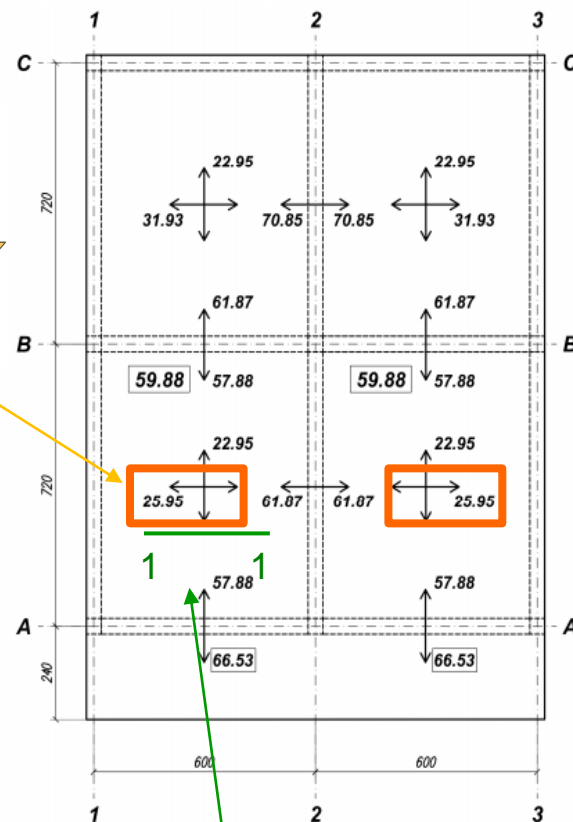
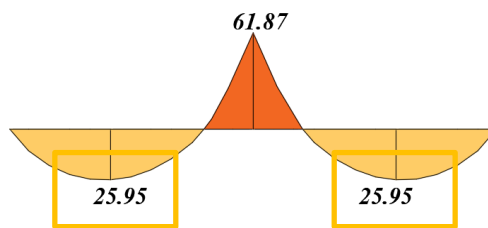

Dimenzionisanje ploče

5.4. Donja zona - duži pravac

5.4.1. $M_{y,Ed} = 22.95 \text{ kNm/m}$

pret. $d_{1,y} = 4.5 \text{ cm} (= 3.0 + 1.0 + 1.0/2 = 4.5 \text{ cm})$

$d_y = 16 - 4.5 = 11.5 \text{ cm}; b = 100 \text{ cm}$

$$k = \frac{11.5}{\sqrt{\frac{22.95}{1.7}}} = 3.130$$

$\varepsilon_c/\varepsilon_s = 3.5/23.0 \text{ ‰}; \omega_1 = 10.692 \text{ ‰}$

$$A_s = 10.692 \times 11.5 \times \frac{1.7}{43.5} = 4.87 \text{ cm}^2/\text{m}$$

pret. $\emptyset 10 (a_s = 0.785 \text{ cm}^2) \rightarrow s = \frac{100 \times 0.785}{4.87} = 16.12 \text{ cm}$

usvojeno: $\emptyset 10/15 (A_{s,usv} = 5.23 \text{ cm}^2/\text{m})$

$$d_{1,y} = 3.0 + 1.0 + \frac{1.0}{2} = 4.5 \text{ cm} \rightarrow d_{y,stv} = d_{y,pret} = 11.5 \text{ cm}$$

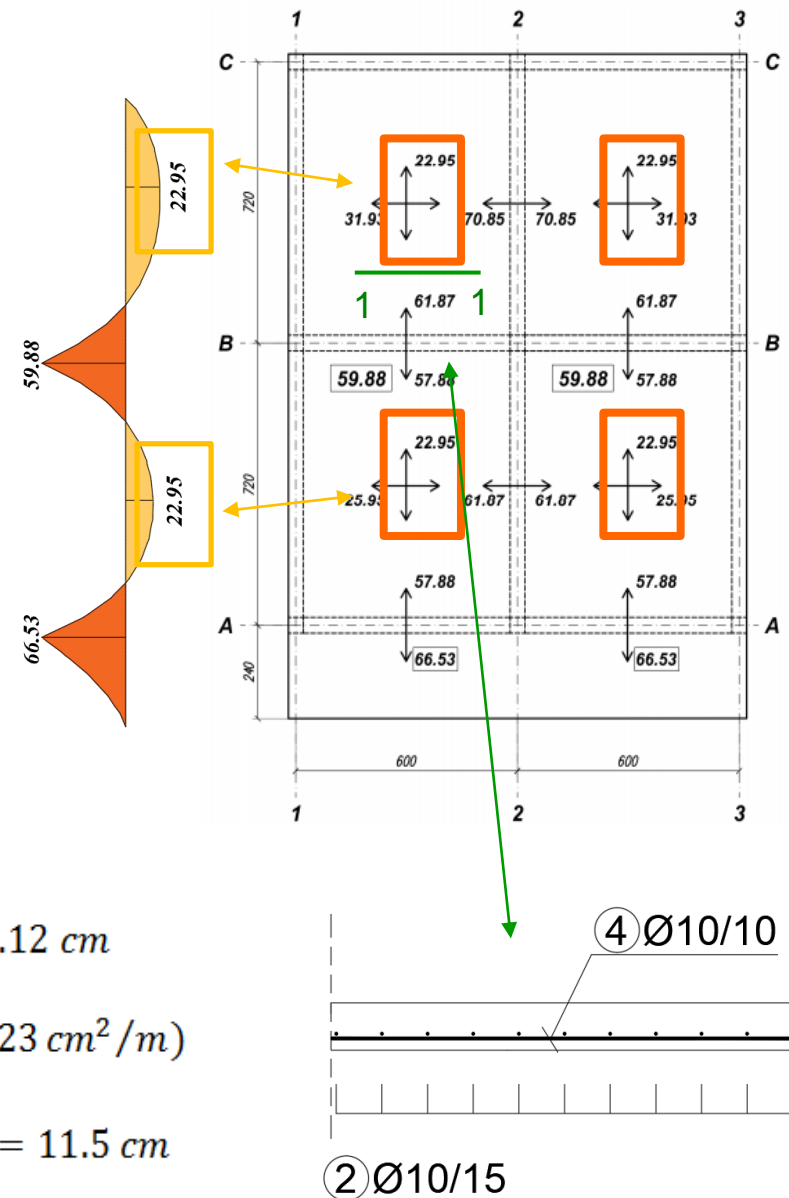

Gornja zona

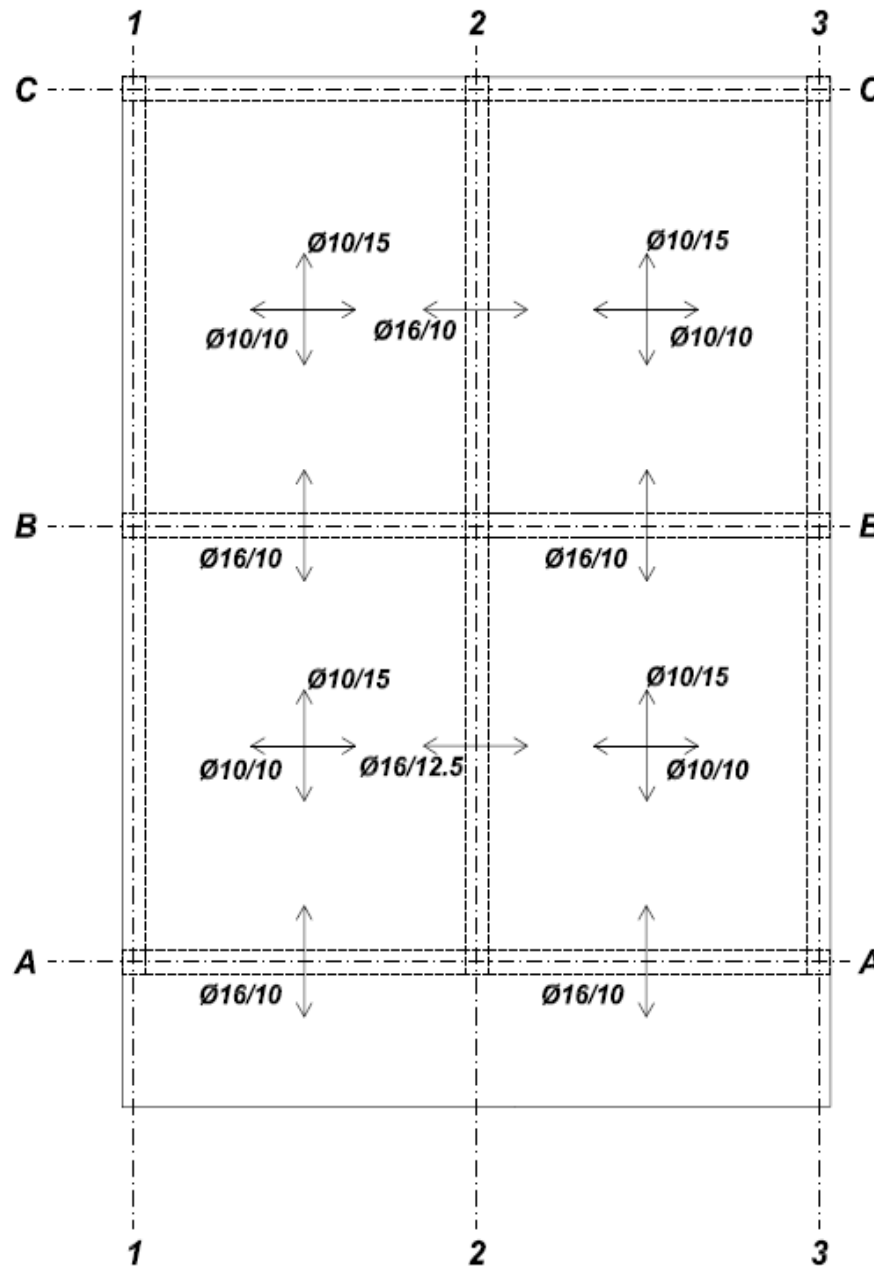

Donja zona

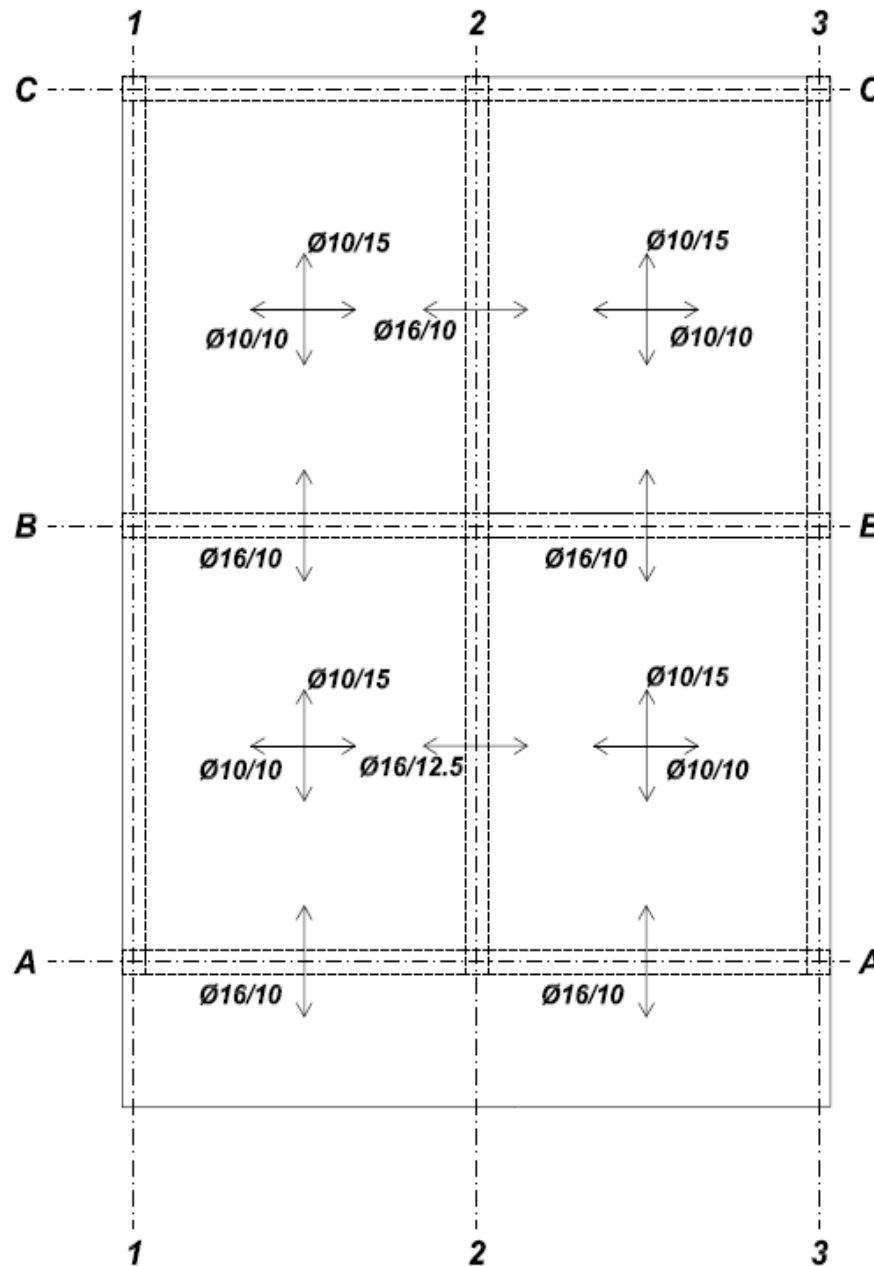

Dimenzionisanje ploče

Reakcije ploče - stalno opterećenje g (kN/m')

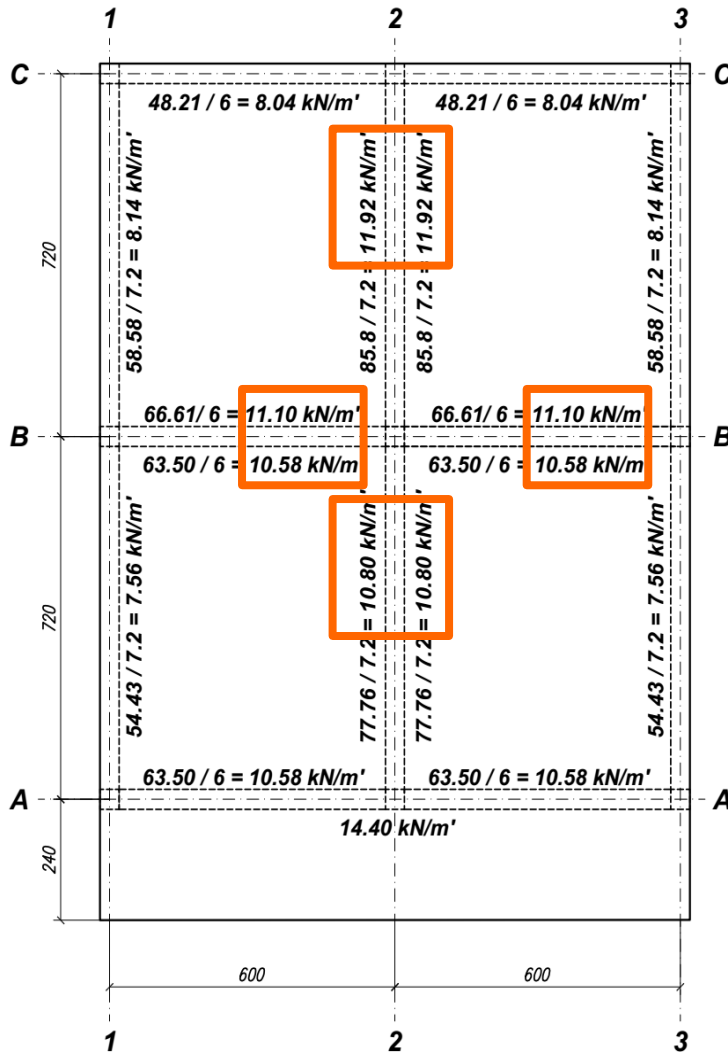

Reakcije ploče - promenljivo opterećenje q (kN/m')

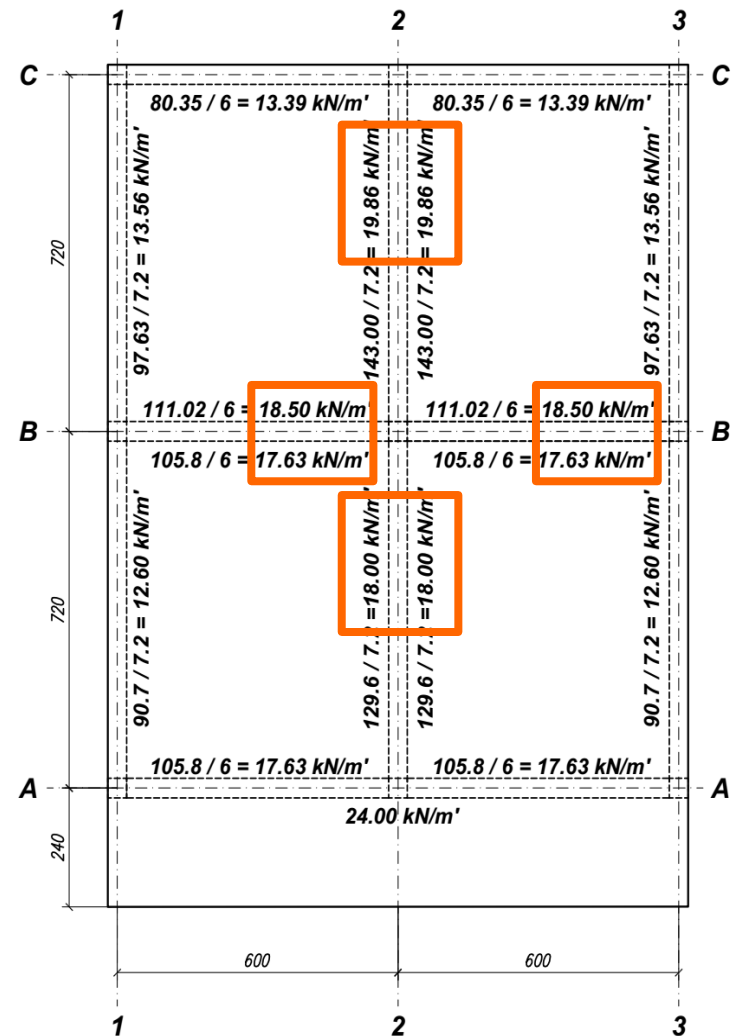

Transverzalne sile

$$V_{Ed} = 1.35 \cdot 14.40 + 1.5 \cdot 24 = 55.44 \frac{kN}{m}$$

$$k = 1 + \sqrt{\frac{200}{120}} = 2.29 > 2! \Rightarrow k$$

$$V_{Rd,c,min} = 0.035 \cdot k^{\frac{3}{2}} \cdot f_{ck}^{\frac{1}{2}} \cdot \frac{bd}{10} = 0.035 \cdot 2.29^{\frac{3}{2}} \cdot 30^{\frac{1}{2}} \cdot \frac{100 \cdot 12}{10} = 65.1 \frac{kN}{m}$$



Ovo je najmanja vrednost **koju** $V_{Rd,c}$ može uzeti, prema tome na strani smo sigurnosti ukoliko proveru smicanja izvršimo na ovaj način.

$$V_{Ed} = 55.44 \text{ kN/m} < V_{Rd,c} = 65.1 \text{ kN/m}$$

Nije potrebno osiguranje (niti dozvoljeno jer je $h < 20 \text{ cm!}$)