

KOLIČINA BETONA:  $V_b = 2 \times 2.05 = 4.10 \text{ m}^3$   
 KOLIČINA ARMATURE:  $\frac{350.03}{4.10} = 85.4 \text{ kg/m}^3$

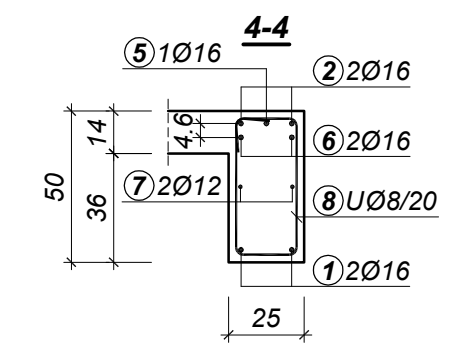
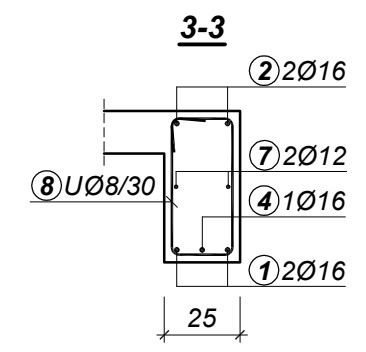
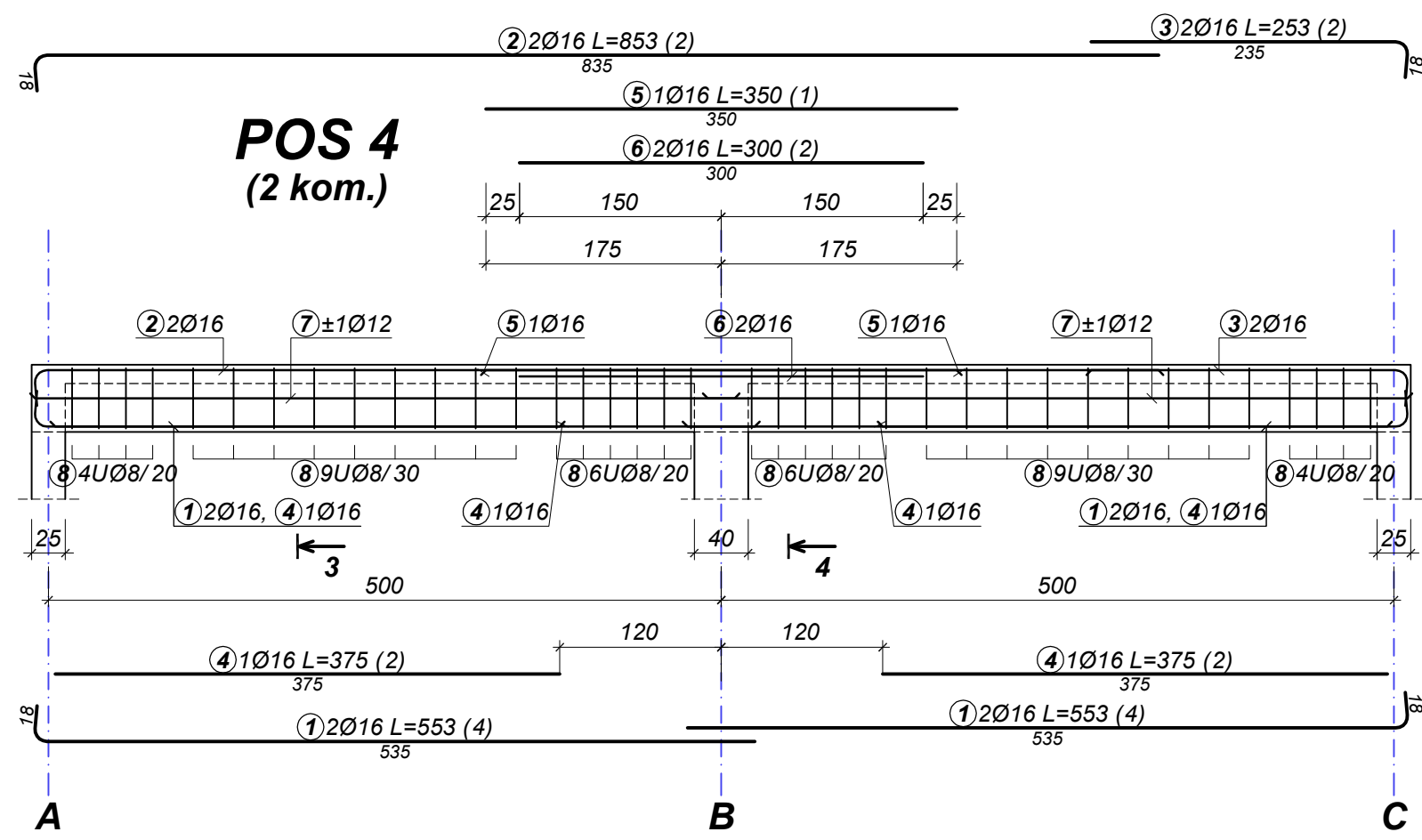
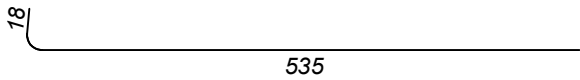
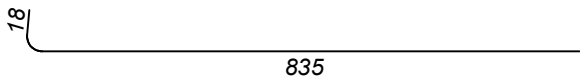
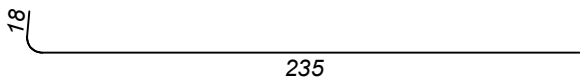
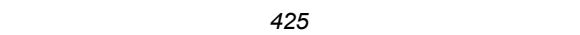
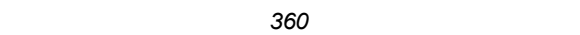
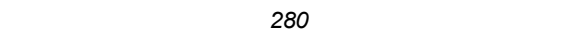
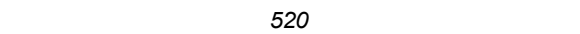
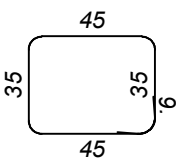

KOLIČINA BETONA:  $V_b = 2 \times 1.28 = 2.56 \text{ m}^3$   
 KOLIČINA ARMATURE:  $\frac{281.99}{2.56} = 110.2 \text{ kg/m}^3$

<b>GRAĐEVINSKI FAKULTET UNIVERZITETA U BEOGRADU</b>			
MODUL MTI		KATEDRA ZA MATERIJALE I KONSTRUKCIJE	
BETONSKE KONSTRUKCIJE 2		PRIMER P04 - LIST br. 2	
PREDMETNI NASTAVNIK: <b>PROF.DR S. MARINKOVIĆ</b>	ASISTENT: <b>M. STOJANOVIĆ</b>	KANDIDAT:	
<b>PLAN ARMATURE POS 4, POS 5</b>			
KVALITET MATERIJALA MB 30 RA 400/500	RAZMERA CRTEŽA R 1:50/20	FORMAT CRTEŽA 395×297	ŠKOLSKA 2016/2017. OVERA: 11.10.2016.

<b>Šipke – specifikacija uz List 2</b>						
ozn.	oblik i mere [cm]	ozn.	Ø	lg [m]	n [kom]	lgn [m]
<b>POS 5 (2 kom)</b>						
1		RA2	16	5.53	8	44.24
2		RA2	16	8.53	4	34.12
3		RA2	16	2.53	4	10.12
4		RA2	16	4.25	8	34.00
5		RA2	16	3.60	4	14.40
6		RA2	16	2.80	4	11.20
7		RA2	12	5.20	8	41.60
8		RA2	8	1.78	100	178.00
<b>Šipke – rekapitulacija (POS 5)</b>						
Ø [mm]	lgn [m]	Jedinična težina [kg/m']		Težina [kg]		
<b>RA2</b>						
8	178.00	0.405		72.09		
12	41.60	0.911		37.90		
16	148.08	1.621		240.04		
<b>Ukupno</b>						<b>350.03</b>

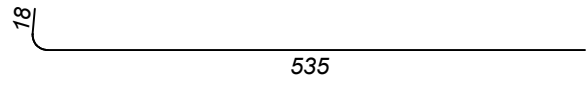
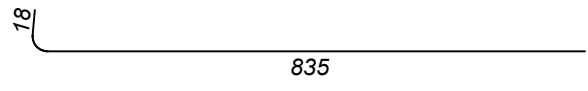
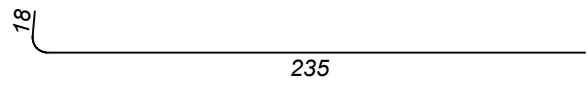
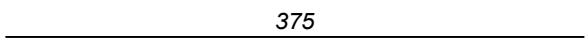
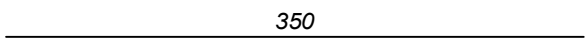
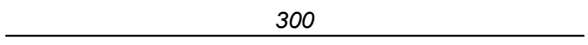
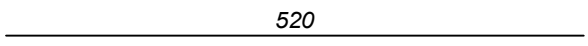
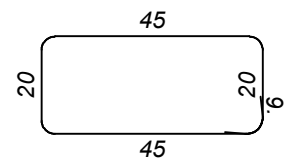
<b>Šipke – specifikacija uz List 2</b>						
ozn.	oblik i mere [cm]	ozn.	Ø	lg [m]	n [kom]	lgn [m]
<b>POS 4 (2 kom)</b>						
1		RA2	16	5.53	8	44.24
2		RA2	16	8.53	4	34.12
3		RA2	16	2.53	4	10.12
4		RA2	16	3.75	4	15.00
5		RA2	16	3.50	2	7.00
6		RA2	16	3.00	4	12.00
7		RA2	12	5.20	8	41.60
8		RA2	8	1.48	76	112.48
<b>Šipke – rekapitulacija (POS 4)</b>						
Ø [mm]	lgn [m]	Jedinična težina [kg/m']		Težina [kg]		
<b>RA2</b>						
8	130.24	0.405		45.55		
12	41.60	0.911		37.90		
16	122.48	1.621		198.54		
<b>Ukupno</b>						<b>281.99</b>

<b>Šipke – rekapitulacija uz List 2</b>			
Ø [mm]	lgn [m]	Jedinična težina [kg/m']	Težina [kg]
<b>RA2</b>			
8	308.24	0.405	117.64
12	83.20	0.911	75.80
16	270.56	1.621	438.58
<b>Ukupno</b>			<b>632.02</b>