



Univerzitet u Beogradu – Građevinski fakultet
www.grf.bg.ac.rs

Studijski program:

GRAĐEVINARSTVO

Godina/Semestar:

III godina / V semestar

Naziv predmeta (šifra):

Teorija betonskih konstrukcija 1
(B3O3B1)

Nastavnik:

Jelena Carević / Stefan Ž. Mitrović / Milica Vidović

Naslov predavanja:

Ploče u jednom pravcu

Datum :

03.12.2024.

Beograd, 2023.

Sva autorska prava autora prezentacije i/ili video snimaka su zaštićena. Snimak ili prezentacija se mogu koristiti samo za nastavu studenata Građevinskog fakulteta Univerziteta u Beogradu u školskoj 2023/2024. i ne mogu se koristiti za druge svrhe bez pismene saglasnosti autora materijala.

1. Ploče u jednom pravcu

- *Prenose opterećenje samo u jednom pravcu*



1. Ploče u jednom pravcu

Ploče oslonjene na četiri strane proračunavaju se kao:

1. Ploče koje prenose opterećenje u jednom pravcu

$$l_y > 2l_x$$

2. Ploče koje prenose opterećenje u oba pravca (krstasto armirane ploče)

$$l_y \leq 2l_x$$

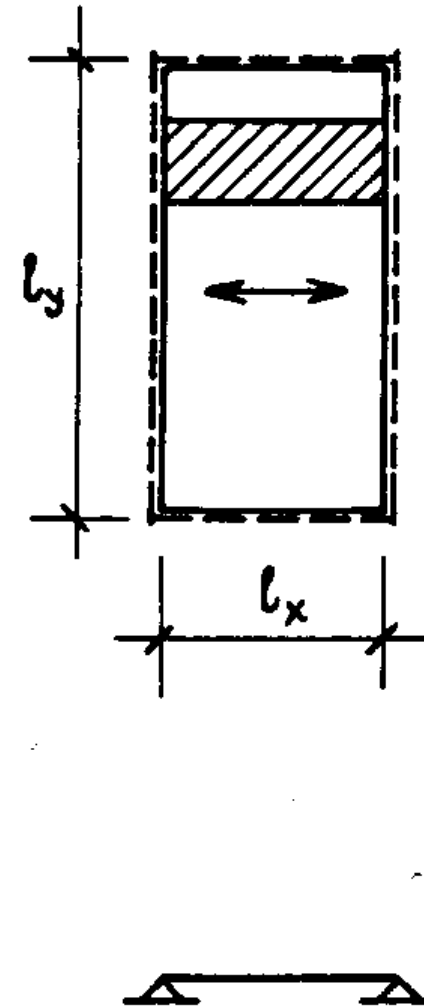

1. Ploče u jednom pravcu

- Proračunavaju se kao linijski elementi

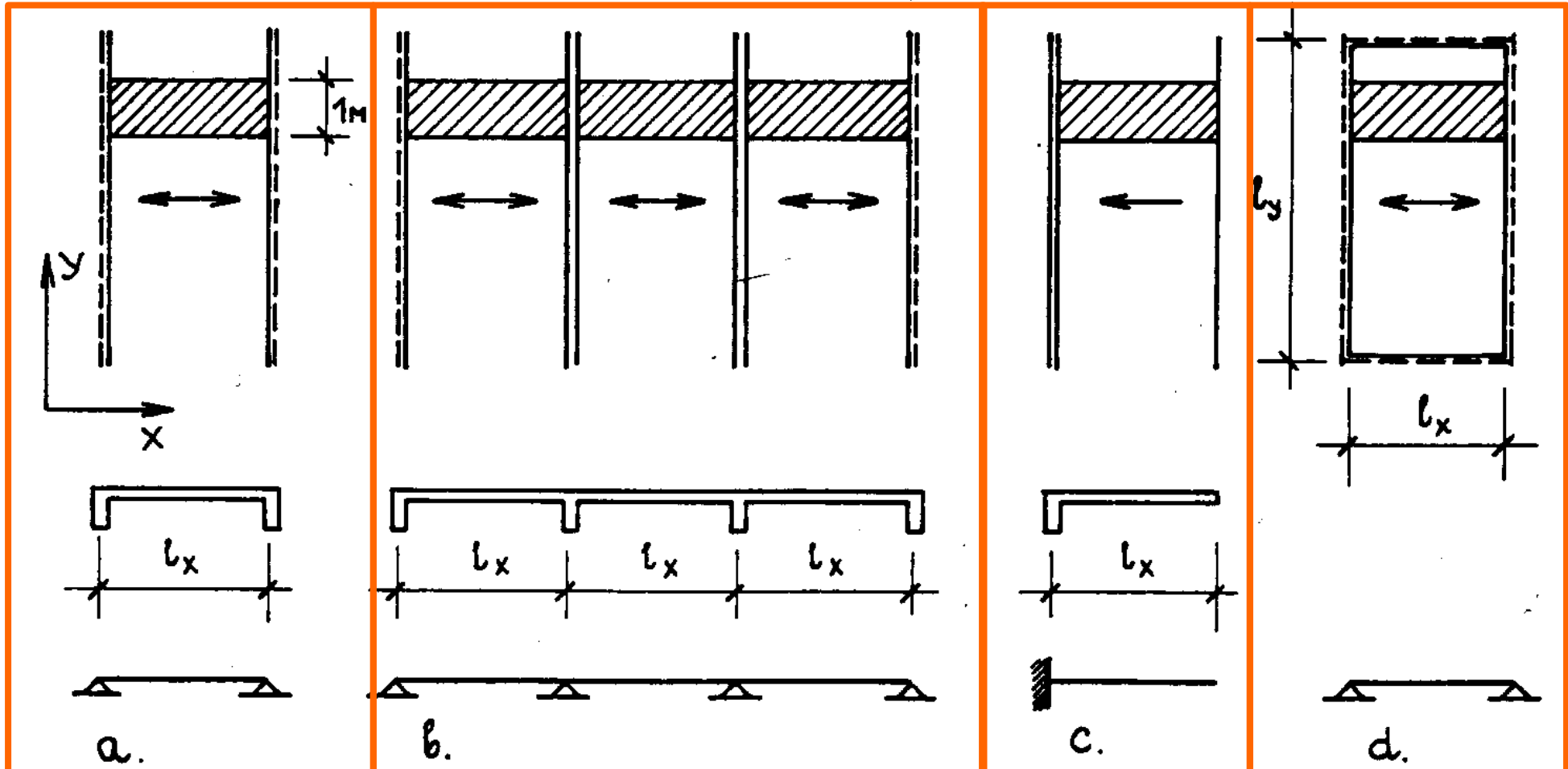
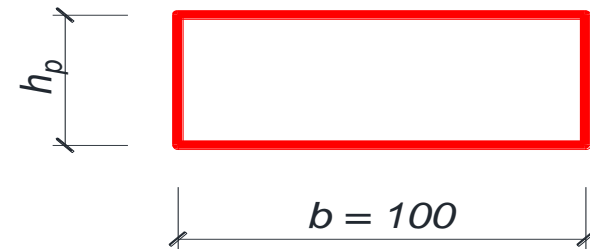

1. Ploče u jednom pravcu

- Proračunavaju se kao linijski elementi

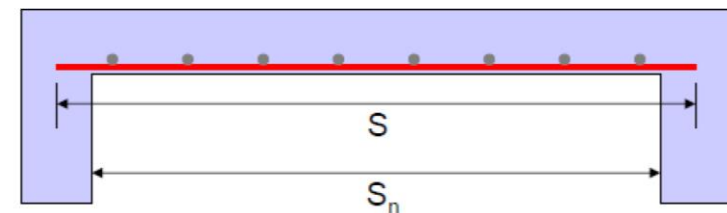
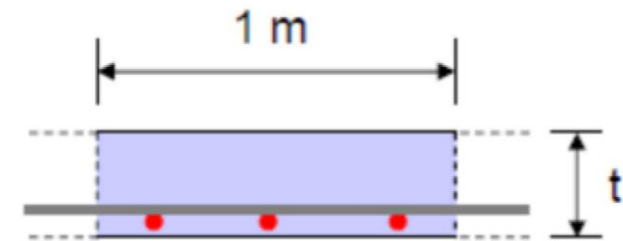
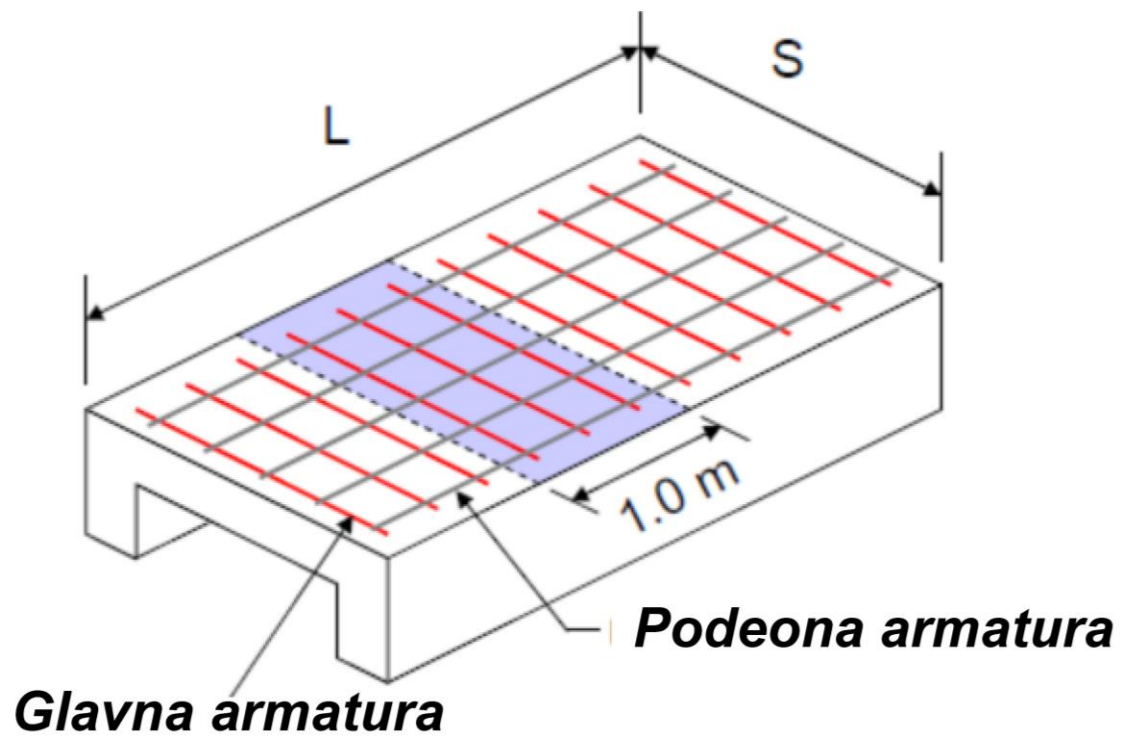

1. Ploče u jednom pravcu

- Ploče se **računaju** na dužni metar, **dimenzionišu** na dužni metar i **armatura** se dobija na dužni metar:

$$k = \frac{d}{\sqrt{\underbrace{b}_{\substack{\text{100cm} \\ \parallel}} \times f_{cd}}} \xrightarrow{\text{TABLICE}} \omega_1 \quad \Rightarrow \quad A_{s1} = \omega_1 \cdot \underbrace{b}_{\substack{\text{100cm} \\ \parallel}} \cdot d \cdot \frac{f_{cd}}{f_{yd}}$$

$$A_{s1} = \omega_1 \cdot \frac{b \cdot d}{100} \cdot \frac{f_{cd}}{f_{yd}} = \omega_1 \cdot \frac{100 \cdot d}{100} \cdot \frac{f_{cd}}{f_{yd}} = \boxed{\omega_1 \cdot d \cdot \frac{f_{cd}}{f_{yd}}}$$

1. Ploče u jednom pravcu

- Sračunata armatura A_{s1} (cm^2/m) – umesto broja šipki na dužnom metru, određuje se razmak između šipki:

- broj šipki: $n = \frac{A_{s1}}{a_s^{(1)}} \text{ kom /m'}$

- Razmak s , računski potrebnih n šipki na dužni metar:

$$s = \frac{1\text{m}}{n} = \frac{100\text{cm}}{n} = \frac{100}{\frac{A_{s1}}{a_s^{(1)}}} = \frac{100 \cdot a_s^{(1)}}{A_{s1}} [\text{cm}]$$

- Uobičajni razmak šipki glavne armature je 10÷20cm (7.5, 10, 12.5, 15, 20 cm)
- Uobičajni razmak šipki podeone armature je 20÷40cm (15, 20, 25, 30, 40 cm)

1. Ploče u jednom pravcu

(specifični zahtevi SRPS EN1992)

- *Armatura za smicanje u ploči predviđa se za: $h \geq 20 \text{ cm}$*
- *Ukoliko je u pločama ispunjen uslov:*

$$|V_{Ed}| \leq \frac{1}{3} V_{Rd, \max}$$

sva armatura za smicanje može da se sastoji od koso povijenih šipki ili od drugih oblika armature za smicanje

2. Primer 1

Ploča POS 1 je sistema kontinualnog nosača preko dva polja raspona $\lambda=6.0$ m

$$\Delta g = 2.0 \text{ kN/m}^2$$

$$q = 3.0 \text{ kN/m}^2$$

*C25/30
B500B
XC2*

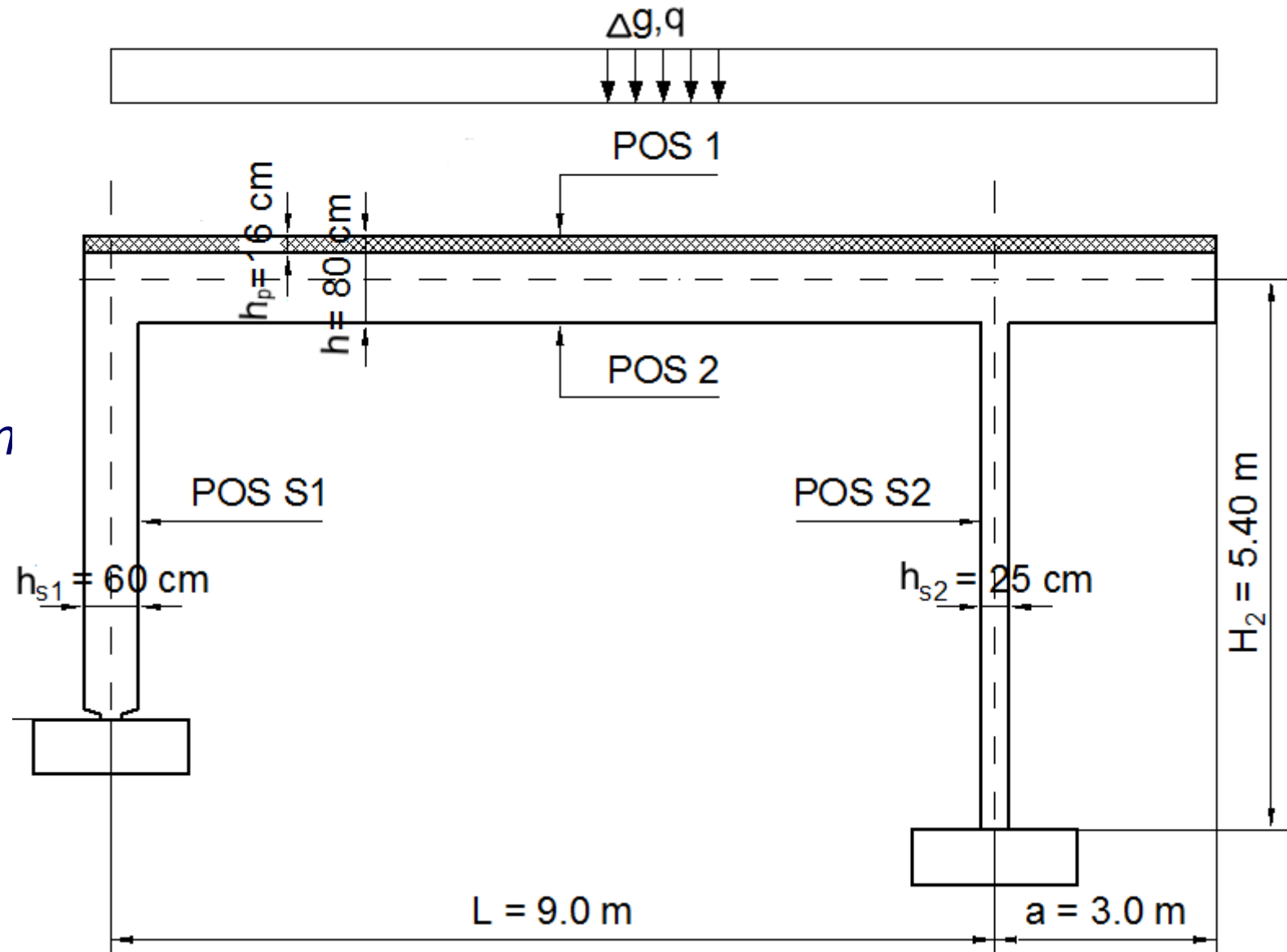

2. Primer 1

ANALIZA OPTEREĆENJA

a. stalno opterećenje

- sopstvena težina ploče	0.16×25	$= 4.0 \text{ kN/m}^2$
- <u>slojevi, izolacije</u>	Δg	$= 2.0 \text{ kN/m}^2$
ukupno stalno opterećenje	g	$= 6.0 \text{ kN/m}^2$

b. povremeno opterećenje

ukupno povremeno opterećenje	q	$= 3.0 \text{ kN/m}^2$
------------------------------	-----	------------------------

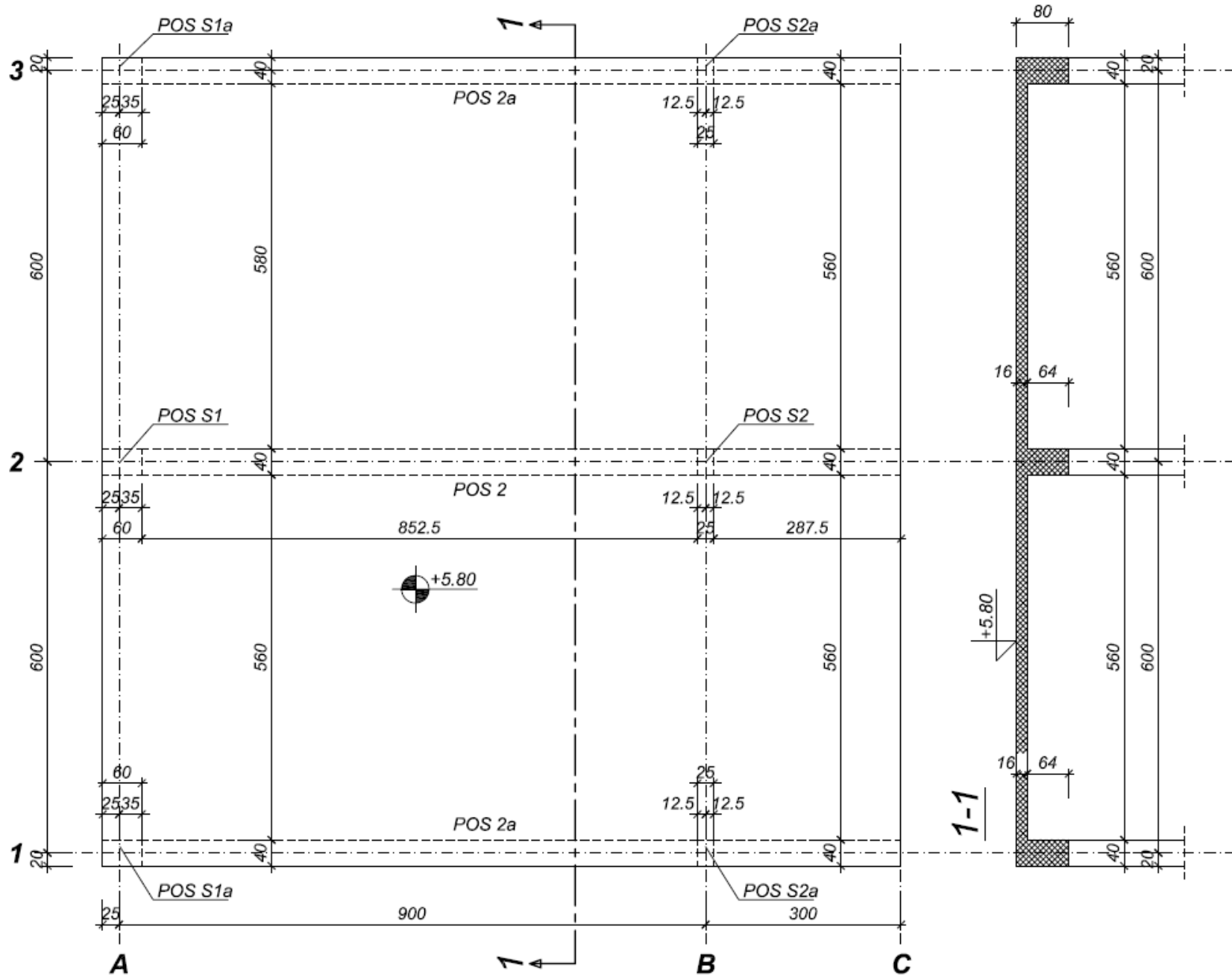

2. Primer 1

PRORAČUN STATIČKIH UTICAJA

stalno opterećenje

$$A_g = 0.375 \times 6.0 \times 6.0 = 13.5 \text{ kN/m} \quad ;$$

$$B_g = 1.25 \times 6.0 \times 6.0 = 45.0 \text{ kN/m} \quad ;$$

$$M_{g,osl} = 0.125 \times 6.0 \times 6.0^2 = 27.0 \text{ kNm/m} \quad ;$$

$$M_{g,polje} = 0.07 \times 6.0 \times 6.0^2 = 15.2 \text{ kNm/m} \quad ;$$

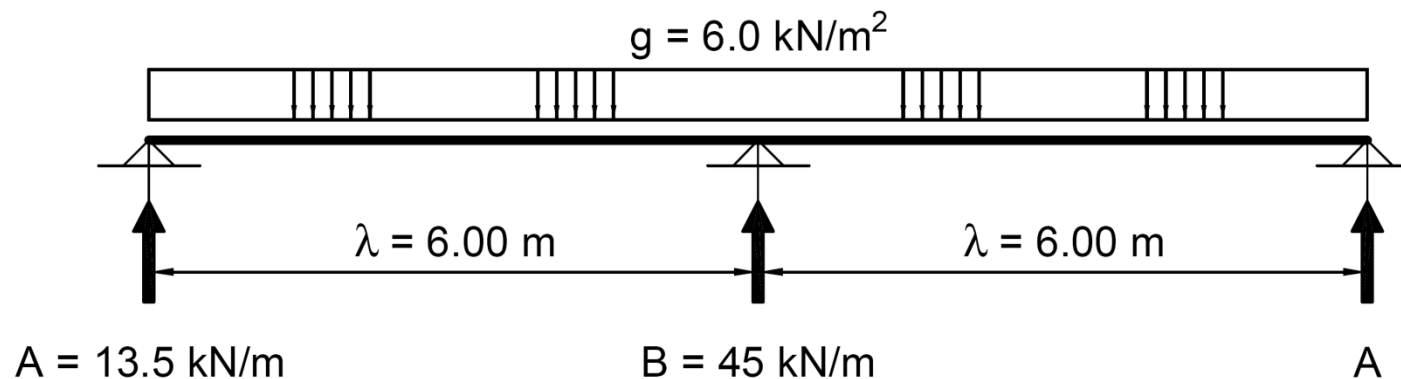

2. Primer 1

povremeno opterećenje

$$A_q = 0.375 \times 3.0 \times 6.0 = 6.75 \text{ kN/m}$$

$$B_q = 1.25 \times 3.0 \times 6.0 = 22.5 \text{ kN/m}$$

$$M_{q_{osl}} = 0.125 \times 3.0 \times 6.0^2 = 13.5 \text{ kNm/m}$$

$$M_{q_{polje}} = 0.07 \times 3.0 \times 6.0^2 = 7.6 \text{ kNm/m}$$

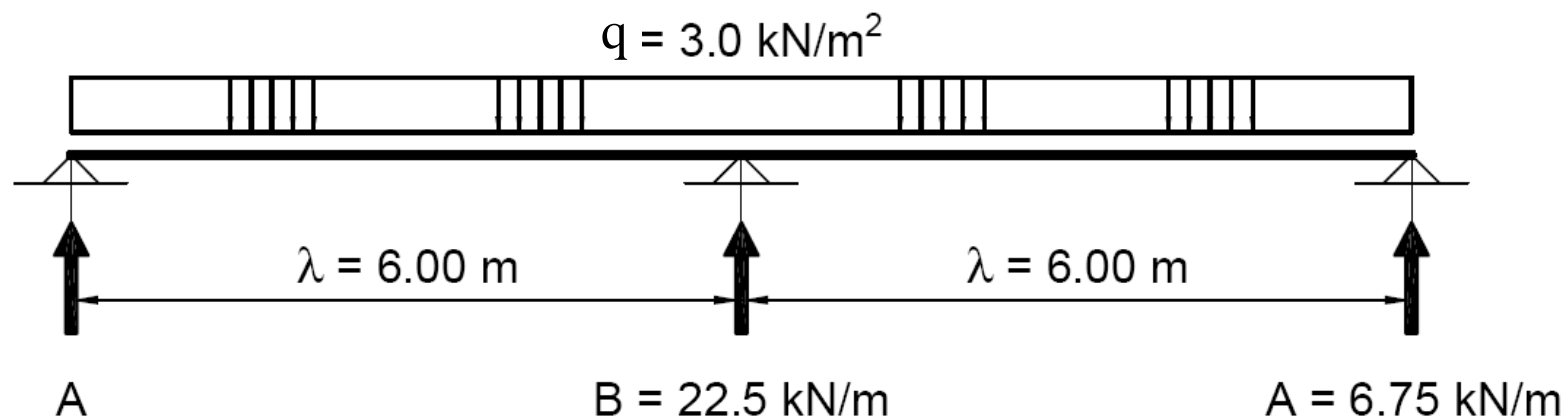

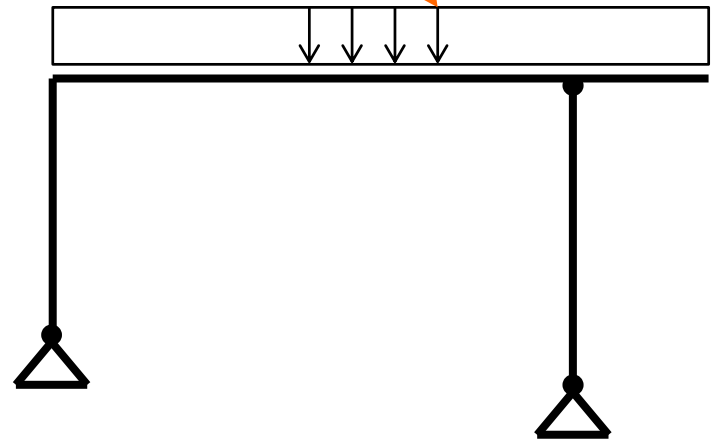
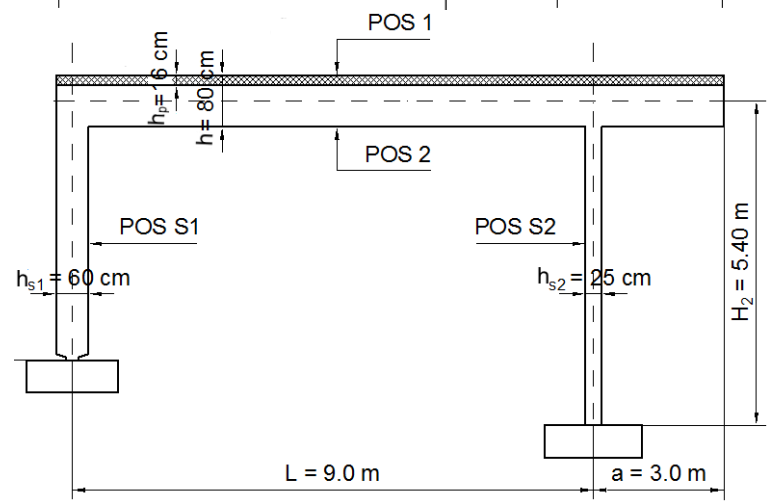
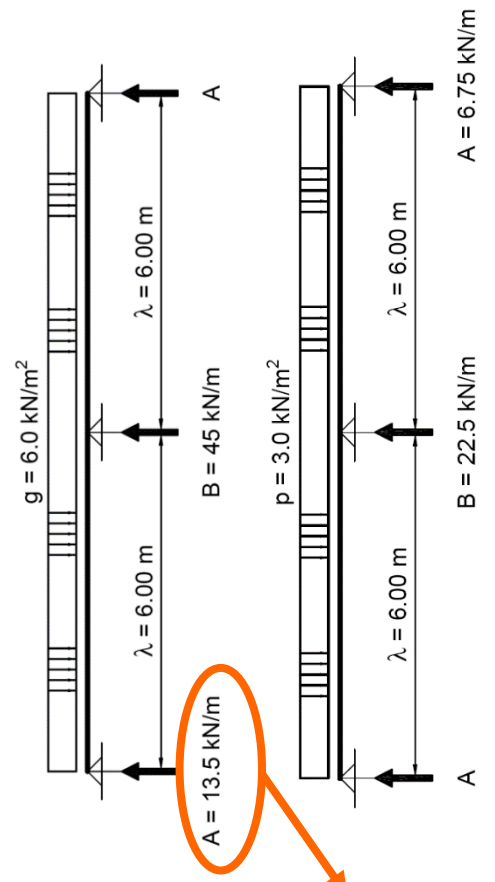
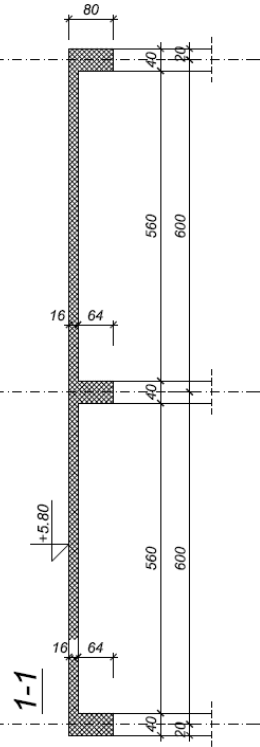
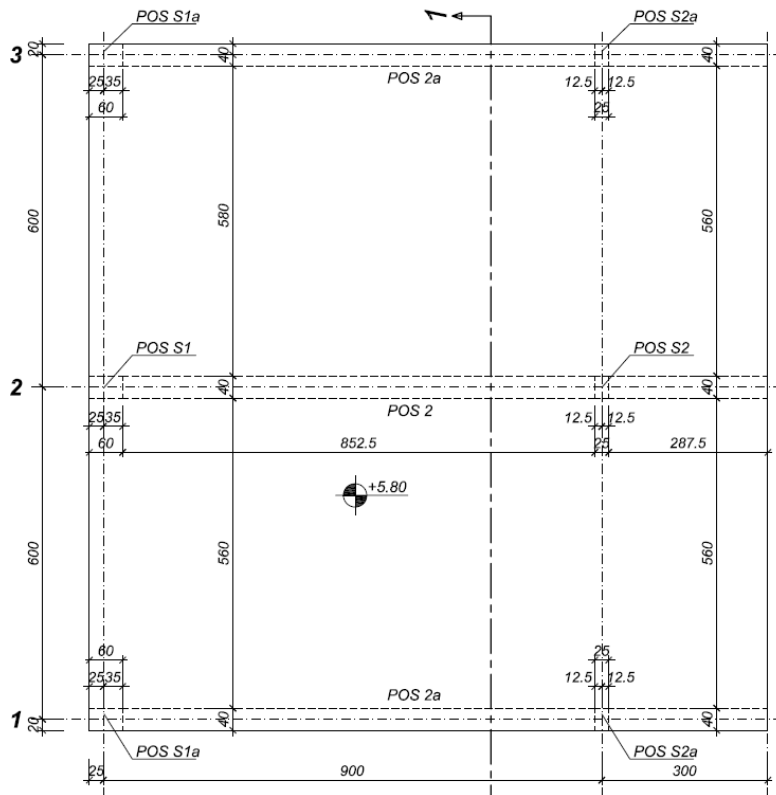

2. Primer 1

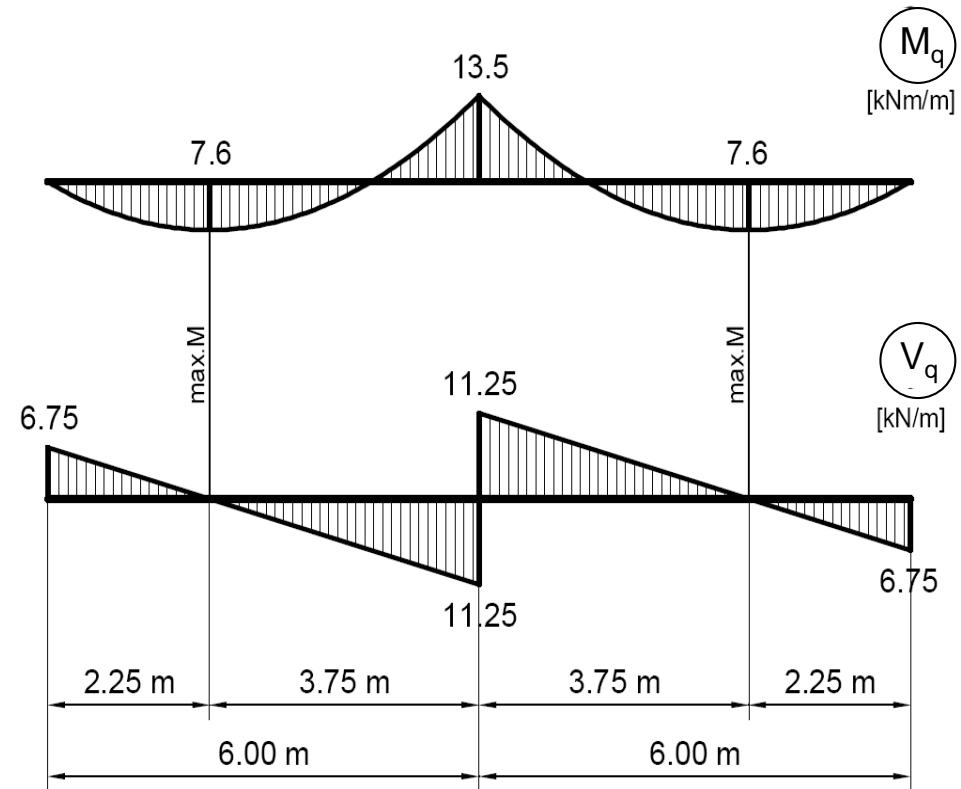
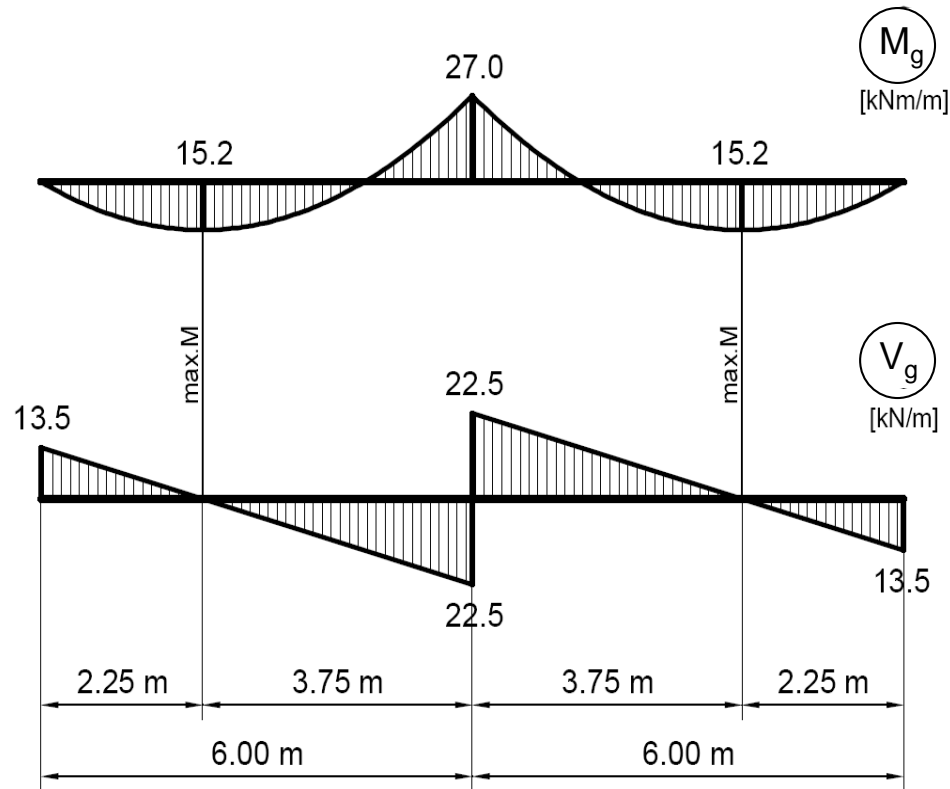

2. Primer 1

- Zaštitni sloj kod ploča:

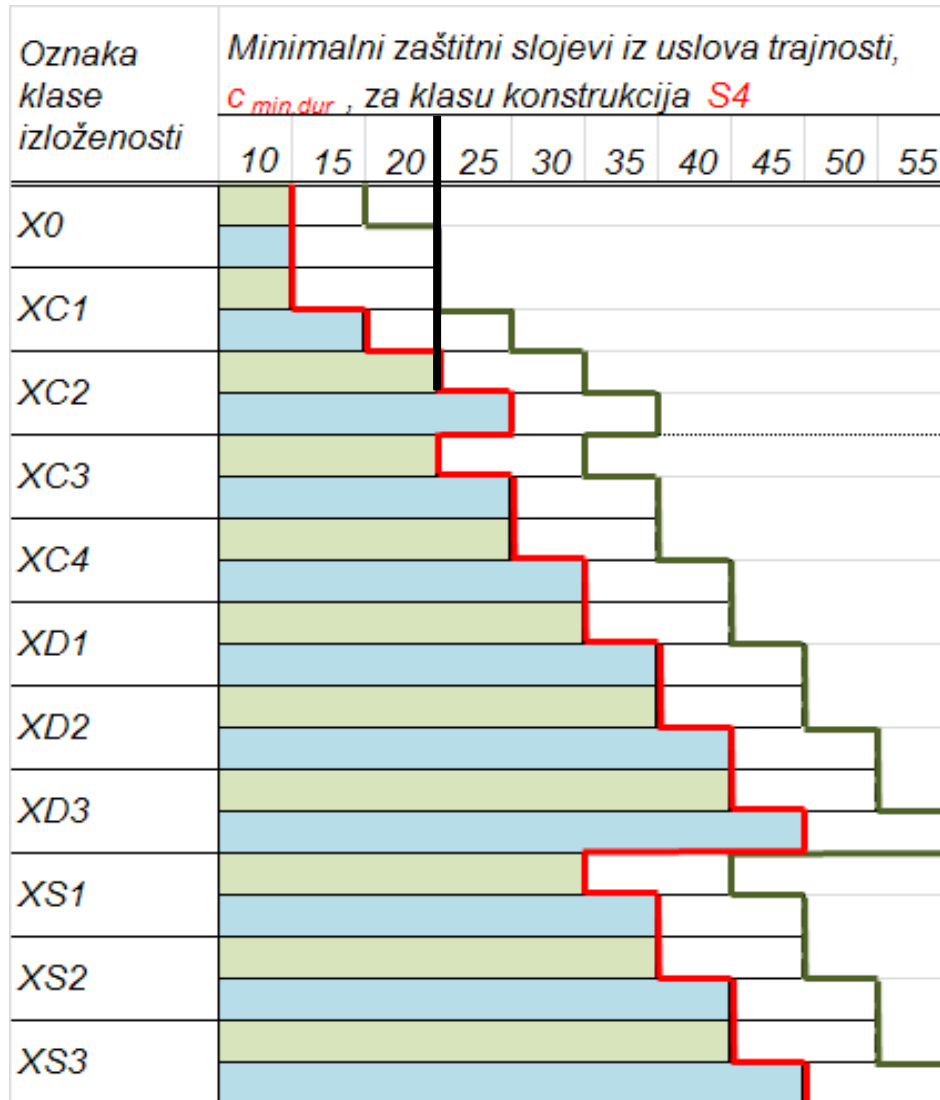

— Upotrební vek 50 god.
— Upotrební vek 100 god.

Tip elementa	Ploče, zidovi
	Grede, stubovi

XC2

2. Primer 1

- Zaštitni sloj kod ploča:

$$c_{nom} = c_{min} + \Delta c_{dev}$$

$$c_{min} = \max\{c_{min,b}; c_{min,dur}; 10 \text{ mm}\} = \max\{16; 20; 10 \text{ mm}\} = 20 \text{ mm}$$

Raspored šipki

Minimalni zaštitni sloj $c_{min,b}^*$

**Pretpostavljeno
 $\varnothing = 16 \text{ mm}$**

Pojedinačne šipke

Prečnik šipke, \varnothing

Šipke u svežnju

Ekvivalentni prečnik (\varnothing_n)

2.Primer 1

DIMENZIONISANJE

$$C25/30 \Rightarrow f_{cd} = 1.42 \text{ kN/cm}^2; B500B \Rightarrow f_{yd} = 43.5 \text{ kN/cm}^2$$

$$XC2 \Rightarrow c_{nom} = 20 + 10 = 30 \text{ mm}$$

Gornja zona

$$M_{Ed} = 1.35 \cdot 27 + 1.5 \cdot 13.5 = 56.7 \text{ kNm/m}$$

$$\text{pretp. } d_1 = 4 \text{ cm} \Rightarrow d = 16 - 4 = 12 \text{ cm}$$

$$k = \frac{12}{\sqrt{\frac{56.7}{1.42}}} = 1.897 \Rightarrow \zeta = 0.827$$

2.Primer 1

$$A_s = \frac{5670}{0.827 \cdot 12 \cdot 43.5} = 13.1 \text{ cm}^2/\text{m}$$

$$\text{pretp. } \emptyset 16 (a_s^{(1)} = 2.01 \text{ cm}^2) \quad s = \frac{100 \cdot a_s^{(1)}}{A_s} = \frac{201}{13.15} = 15.3 \text{ cm}$$

usvojeno $\emptyset 16/15$ (13.4 cm²/m)

$$A_{sp} = 0.2 \cdot 13.1 = 2.62 \text{ cm}^2/\text{m}$$

$$\text{pretp. } \emptyset 10 (a_s^{(1)} = 0.785 \text{ cm}^2) \quad s_p = \frac{100 \cdot a_s^{(1)}}{A_{sp}} = \frac{78.5}{2.62} = 30.0 \text{ cm}$$

usvojeno $\emptyset 10/30$ (2.62 cm²/m)

2.Primer 1

Donja zona

$$M_{Ed} = 1.35 \cdot 15.2 + 1.5 \cdot 7.6 = 31.9 \text{ kNm/m}$$

pretp. $d_1 = 4 \text{ cm} \Rightarrow d = 16 - 4 = 12 \text{ cm}$

$$k = \frac{12}{\sqrt{\frac{31.9}{1.42}}} = 2.528 \Rightarrow \zeta = 0.912$$

2.Primer 1

$$A_s = \frac{3190}{0.912 \cdot 12 \cdot 43.5} = 6.71 \text{ cm}^2/\text{m}$$

$$\text{pretp. } \emptyset 12 (a_s^{(1)} = 1.13 \text{ cm}^2) \quad s = \frac{100 \cdot a_s^{(1)}}{A_s} = \frac{113}{6.71} = 16.8 \text{ cm}$$

usvojeno $\emptyset 12/15$ (7.5 cm²/m)

$$A_{sp} = 0.2 \cdot 6.71 = 1.34 \text{ cm}^2/\text{m}$$

$$\text{pretp. } \emptyset 8 (a_s^{(1)} = 0.503 \text{ cm}^2) \quad s_p = \frac{100 \cdot a_s^{(1)}}{A_{sp}} = \frac{50.3}{1.34} = 37.5 \text{ cm}$$

usvojeno $\emptyset 8/30$ (1.68 cm²/m)

2. Primer 1

- Najveće rastojanje šipki **s** – **glavne armature** u pločama na mestima maksimalnih naprezanja:

Za jednako podeljeno opterećenje

$$s_{maxslabs} = \min \left\{ \begin{array}{l} 3h \\ 40cm \end{array} \right\}$$

Preporuka
20 cm!

Za koncentrisano opterećenje, ili jednako podeljeno ali za zone sa max naprezanjima

$$s_{maxslabs} = \min \left\{ \begin{array}{l} 2h \\ 25cm \end{array} \right\}$$

- Najveće rastojanje šipki **s_p** – **podeone armature** u pločama na mestima maksimalnih naprezanja:

Za jednako podeljeno opterećenje

$$s_{maxslabs} = \min \left\{ \begin{array}{l} 3.5h \\ 45cm \end{array} \right\}$$

Preporuka
30 cm!

Za koncentrisano opterećenje, ili jednako podeljeno ali za zone sa max naprezanjima

$$s_{maxslabs} = \min \left\{ \begin{array}{l} 3h \\ 40cm \end{array} \right\}$$

2. Primer 1

- Standardom su propisani minimalni procenti armiranja glavne armature u odnosu na površinu betonskog preseka $b_t h$

$$A_{s,min} = \max \left\{ \begin{array}{l} 0,26 \frac{f_{ctm}}{f_{yk}} b_t d \\ 0,0013 b_t d \end{array} \right\}$$

f_{ck}	f_{ctm}	Minimum % ($0.26 f_{ctm} / f_{yk}^a$)
25	2.6	0.13%
28	2.8	0.14%
30	2.9	0.15%
32	3.0	0.16%
35	3.2	0.17%
40	3.5	0.18%
45	3.8	0.20%
50	4.1	0.21%

2. Primer 1

- *Maksimalno rastojanje glavne i podeone armature*

$$s_{\max,slabs} = \min \left\{ \begin{array}{l} 2 \cdot 16 = 32cm \\ 25cm \end{array} \right\} = 25cm$$

$$s_{p,\max,slabs} = \min \left\{ \begin{array}{l} 3 \cdot 16 = 48cm \\ 40cm \end{array} \right\} = 40cm$$

- *Minimalni procenat armiranja glavnom armaturom*

$$A_{s,\min} = 0.13 \cdot d = 0.13 \cdot 12 = 1.56cm^2 / m$$

2. Primer 1

Transverzalne sile

$$V_{Ed} = 1.35 \cdot 22.5 + 1.5 \cdot 11.25 = 47.25 \frac{kN}{m}$$

$$k = 1 + \sqrt{\frac{200}{120}} = 2.29 > 2! \Rightarrow k = 2$$

$$V_{Rd,c,min} = 0.035 \cdot k^{\frac{3}{2}} \cdot f_{ck}^{\frac{1}{2}} \cdot bd = 0.035 \cdot 2^{\frac{3}{2}} \cdot 25^{\frac{1}{2}} \cdot 100 \cdot 12/10 = 59.4 \frac{kN}{m}$$

Ovo je najmanja vrednost koju $V_{Rd,c}$ može uzeti, prema tome na strani smo sigurnosti ukoliko proveru smicanja izvršimo na ovaj način.

$$V_{Ed} = 47.25 \text{ kN/m} < V_{Rd,c} = 59.4 \text{ kN/m}$$

Nije potrebno osiguranje (niti dozvoljeno jer je $h < 20 \text{ cm!}$)

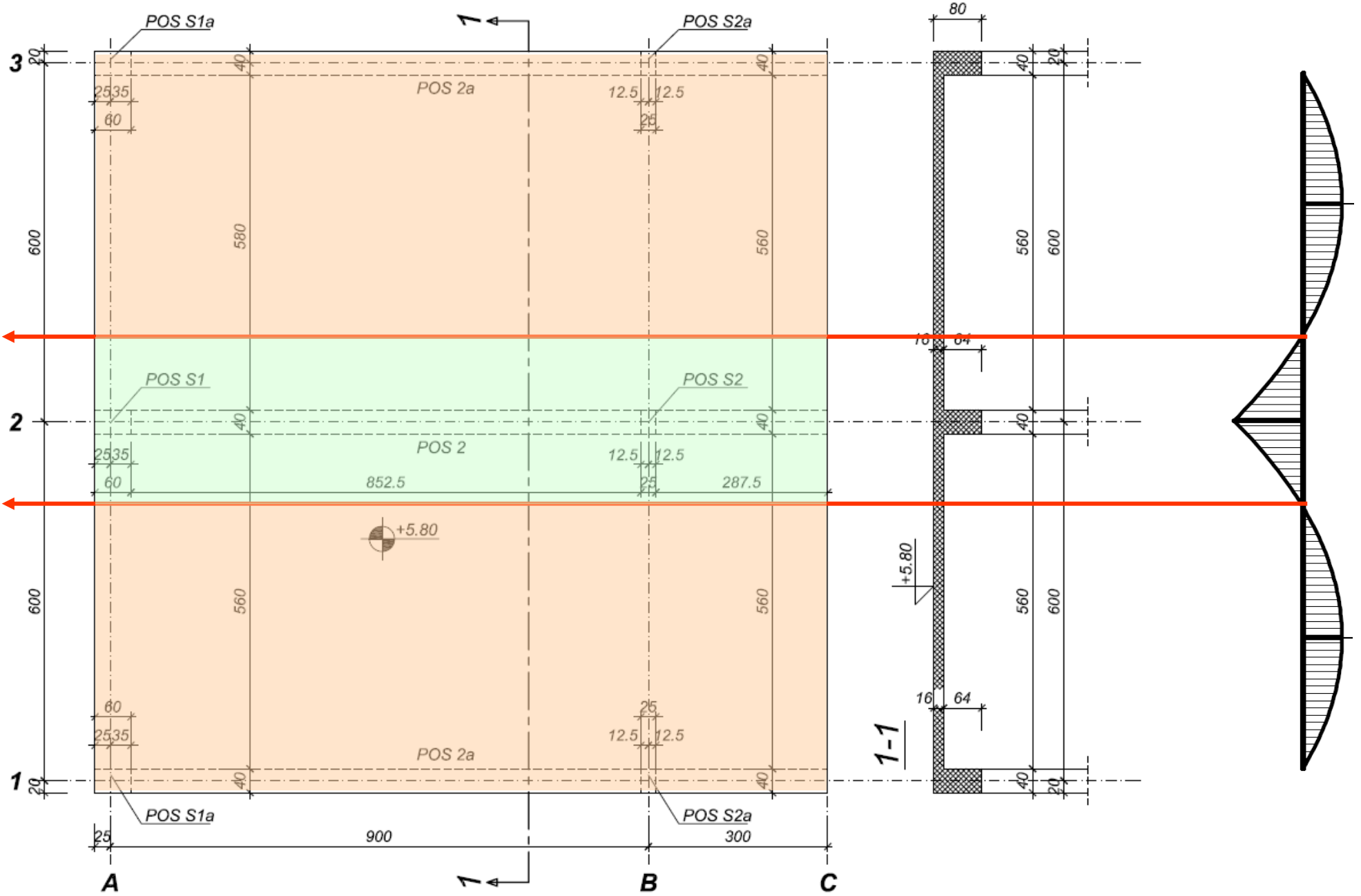

1. Ploče u jednom pravcu

- U kraćem pravcu I_x postavlja se glavna armatura A_s sračunata iz momenta M_x sa većom statičkom visinom na rastojanju s

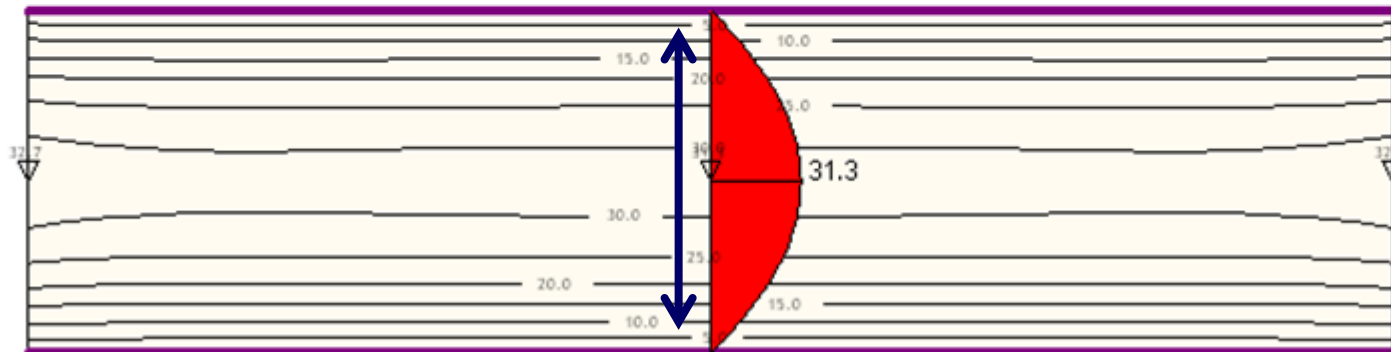
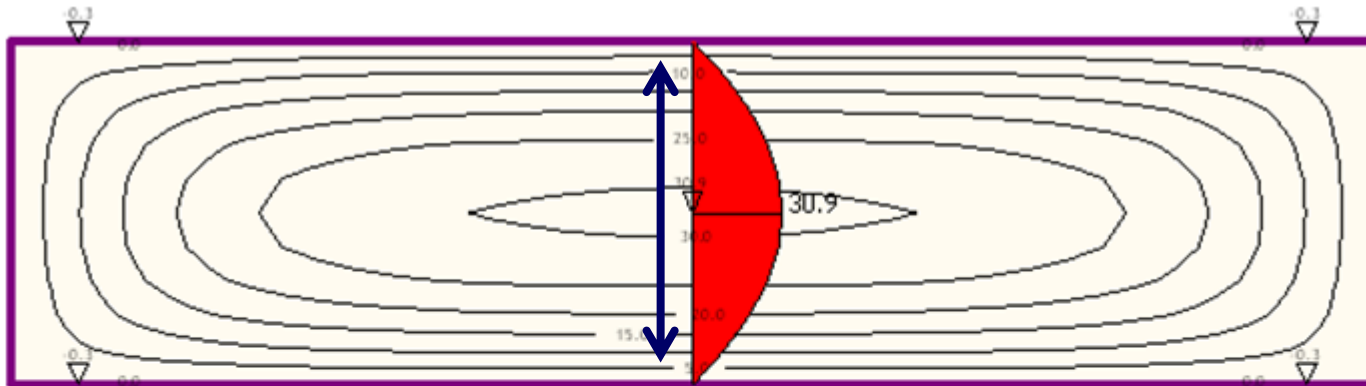

1. Ploče u jednom pravcu

- U kraćem pravcu l_x postavlja se glavna armatura A_s sračunata iz momenta M_x sa većom statičkom visinom na rastojanju s
- U dužem pravcu l_y postavlja se poprečna armatura $A_{sp}=0.2A_s$ sračunata iz momenta M_y sa manjom statičkom visinom na rastojanju s_p

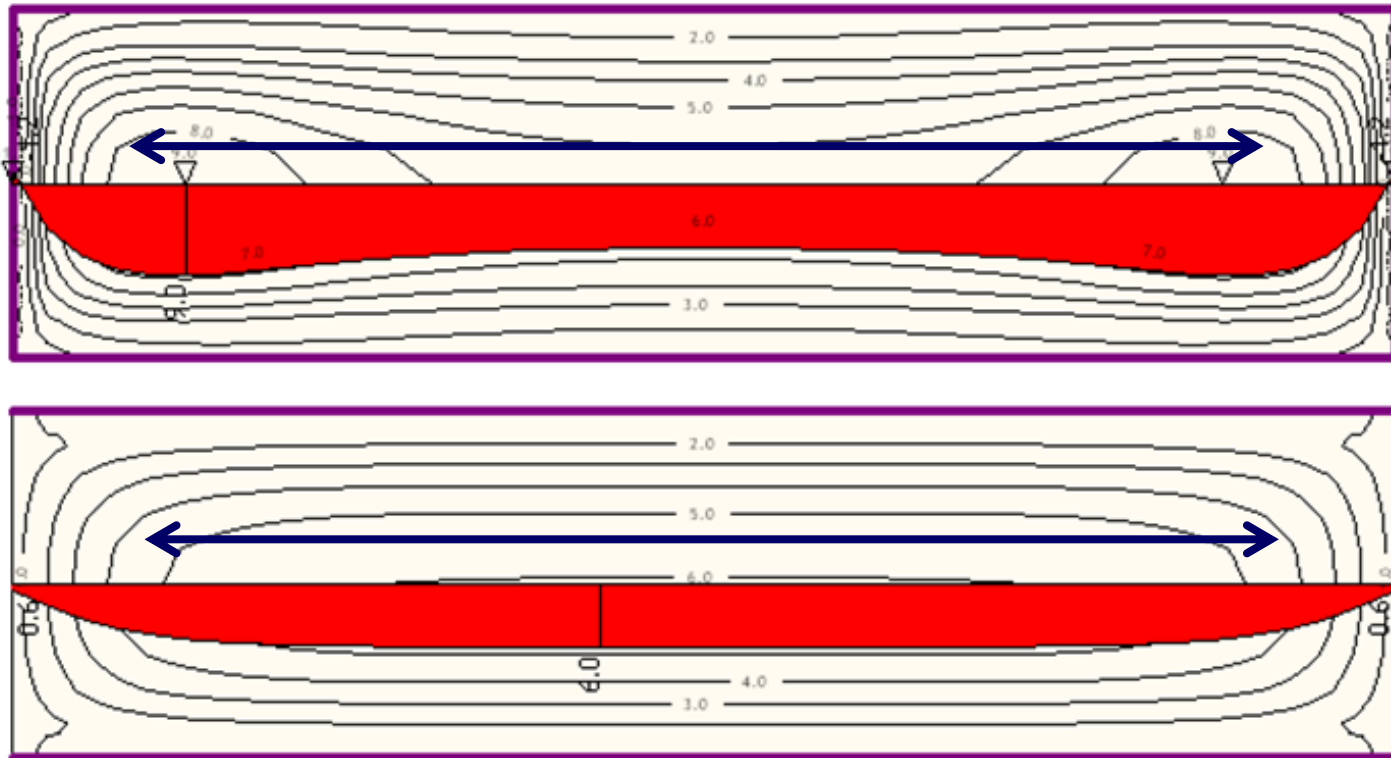

1. Ploče u jednom pravcu

- U kraćem pravcu l_x postavlja se glavna armatura A_s sračunata iz momenta M_x sa većom statičkom visinom na rastojanju s
- U dužem pravcu l_y postavlja se poprečna armatura $A_{sp}=0.2A_s$ sračunata iz momenta M_y sa manjom statičkom visinom na rastojanju s_p

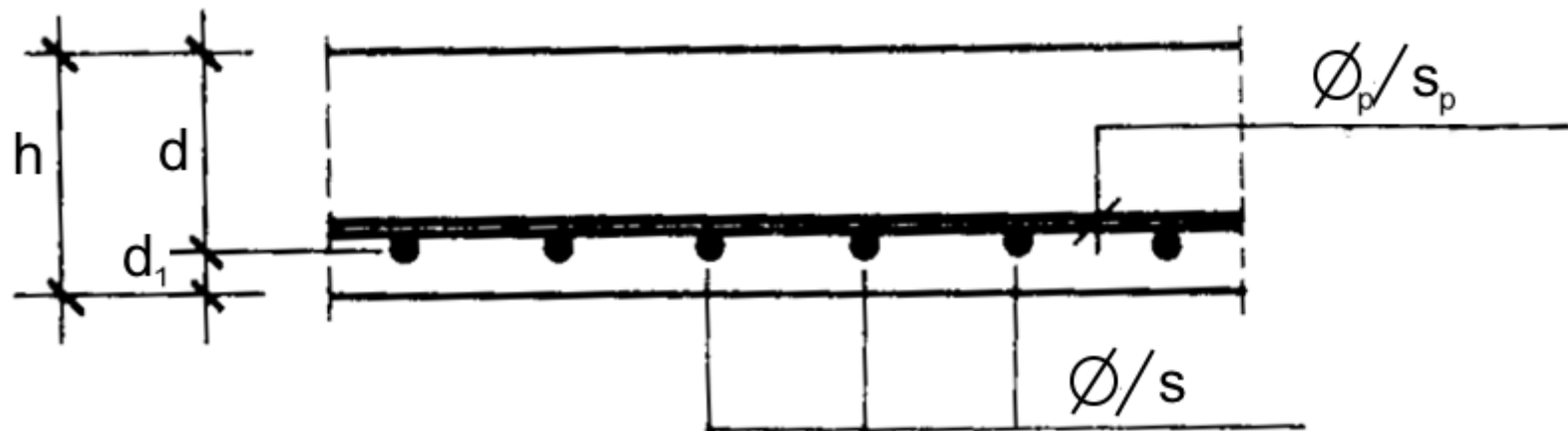

Sidrenje armature

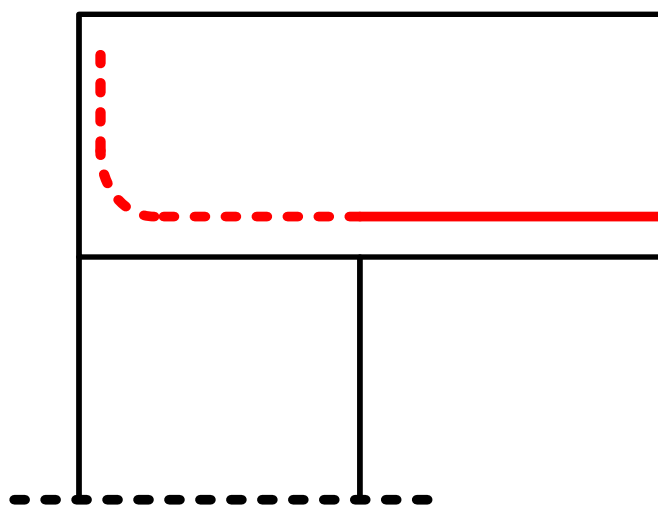
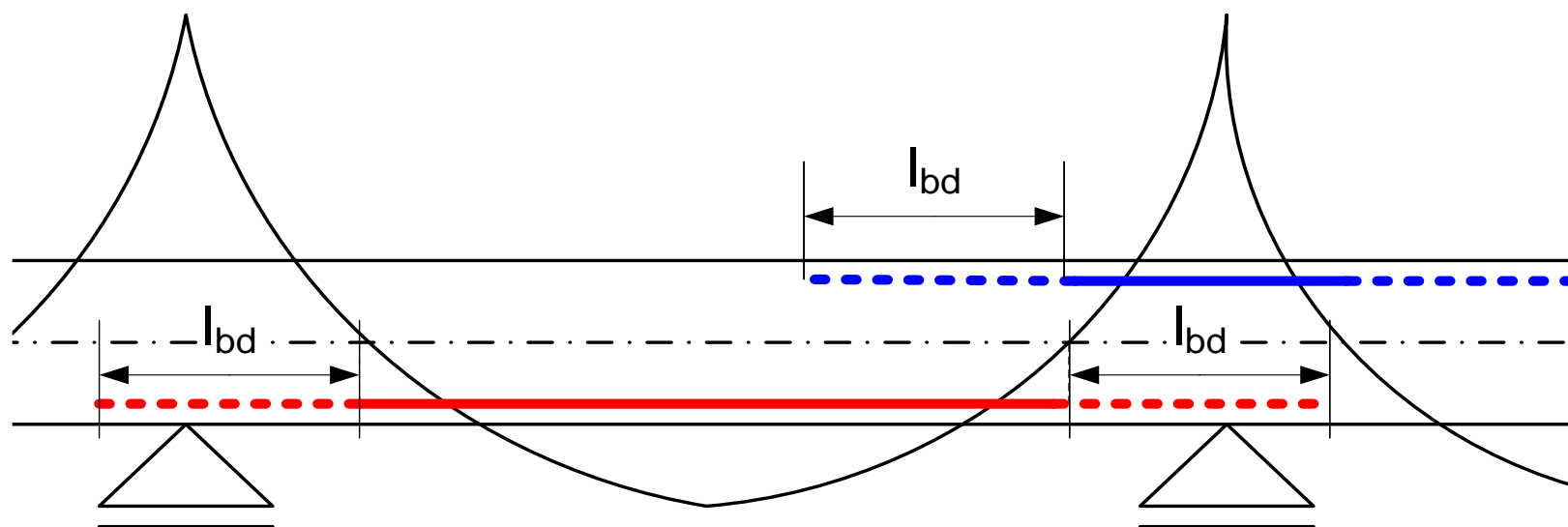

$$l_{\text{šipke}} = l_{\text{stat}} + 2l_{bd} + 2a_1$$

$$a_1 = d$$

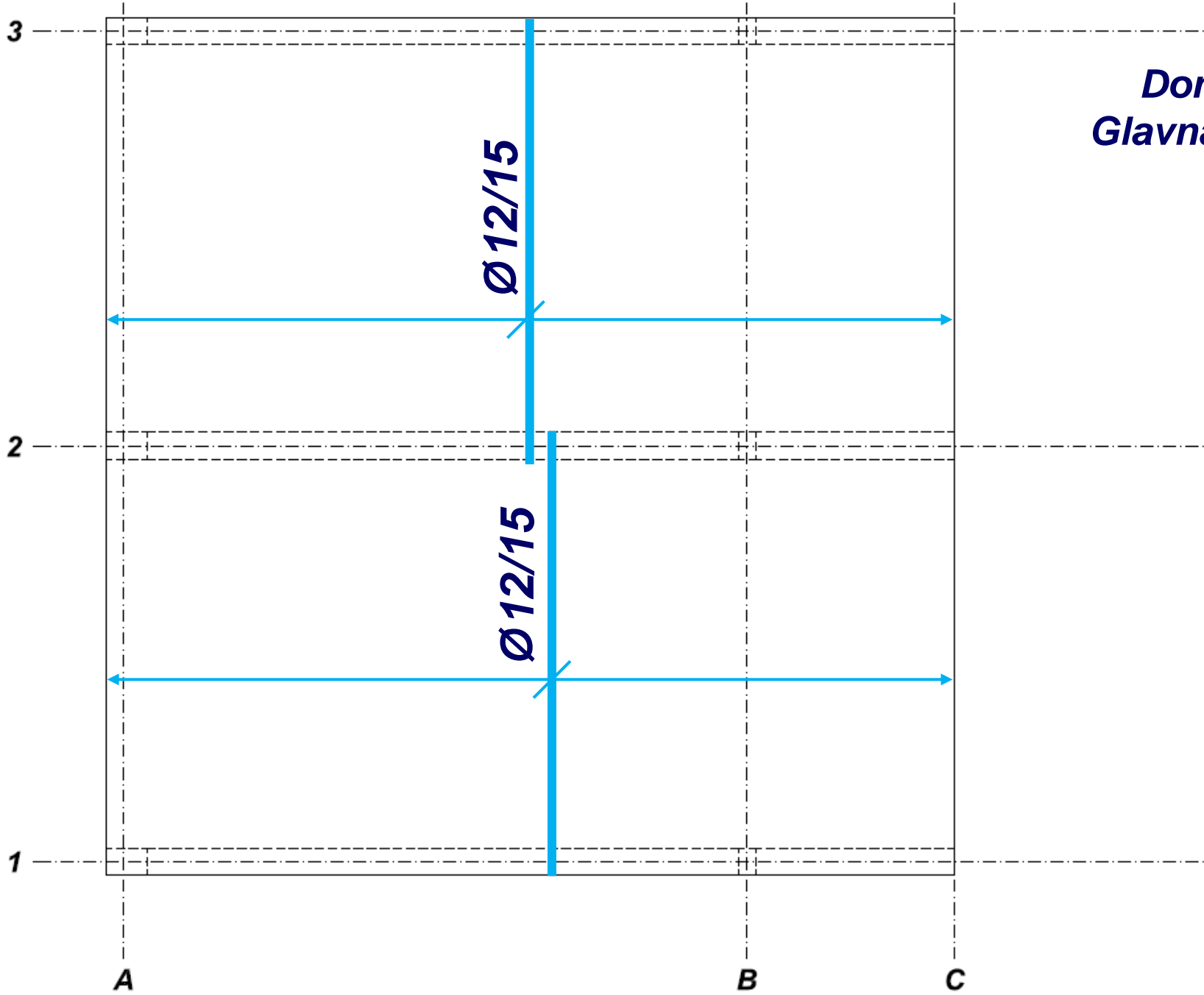

***Donja zona
Glavna armatura***

DONJA ZONA

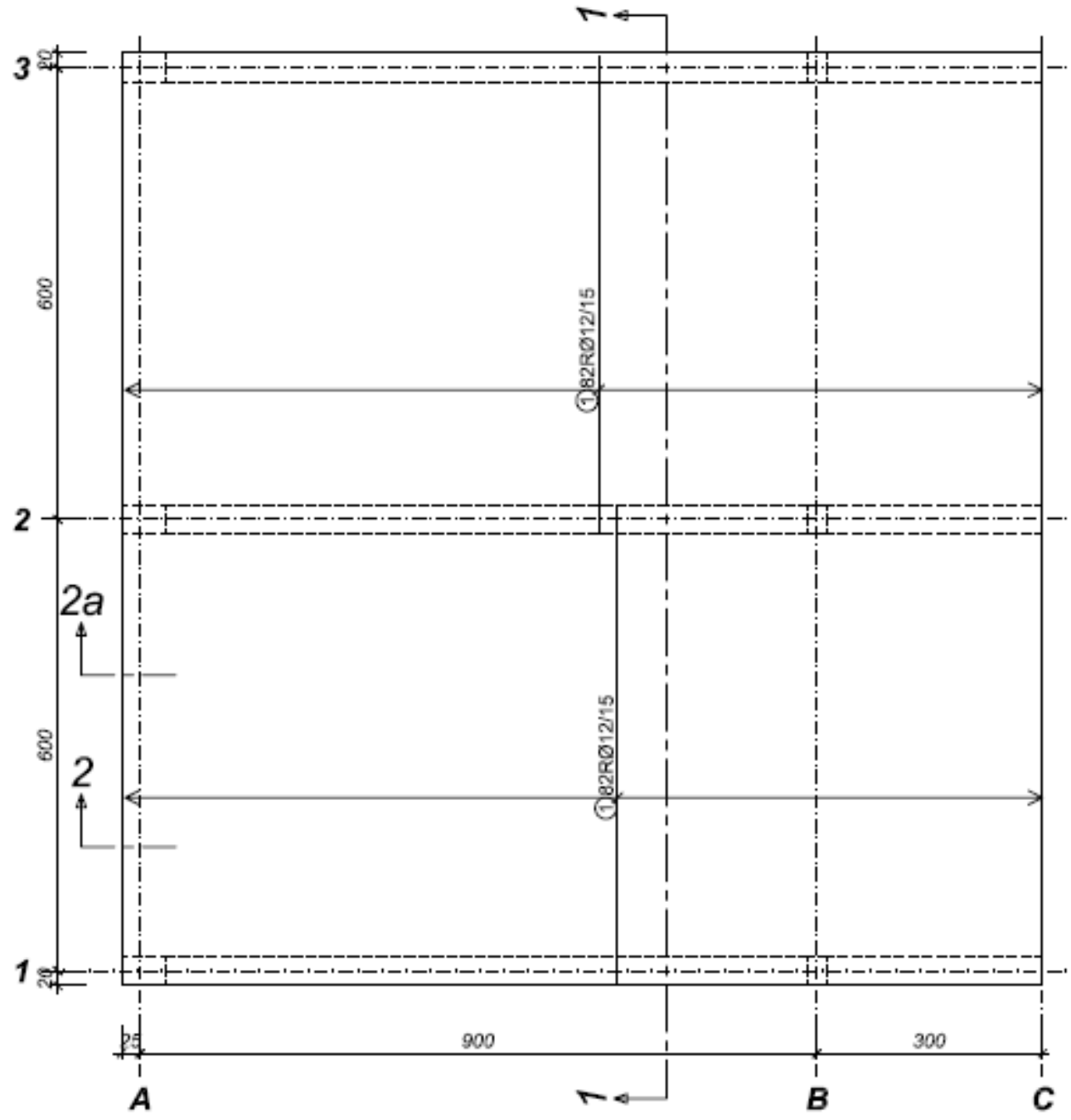

DONJA ZONA

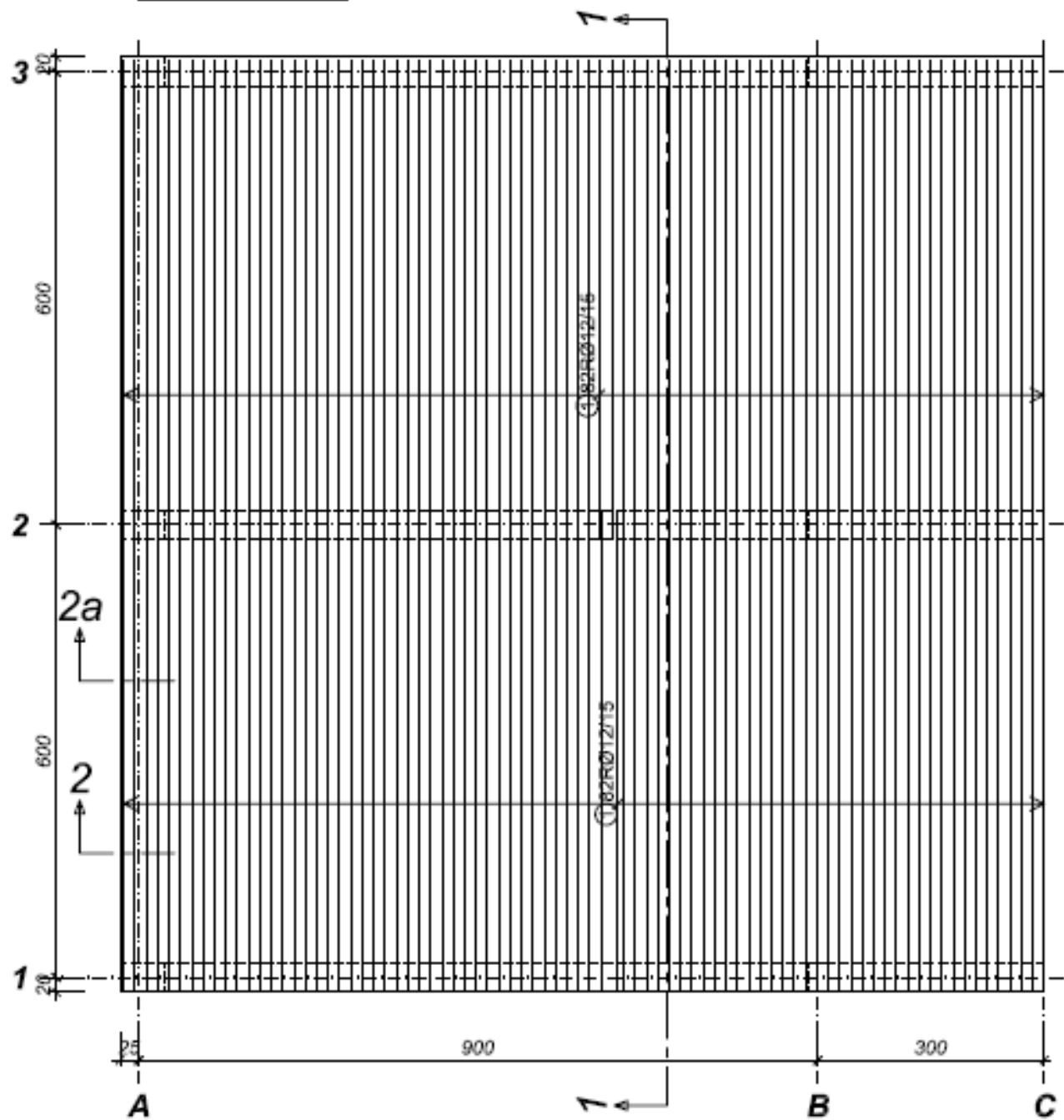

DONJA ZONA

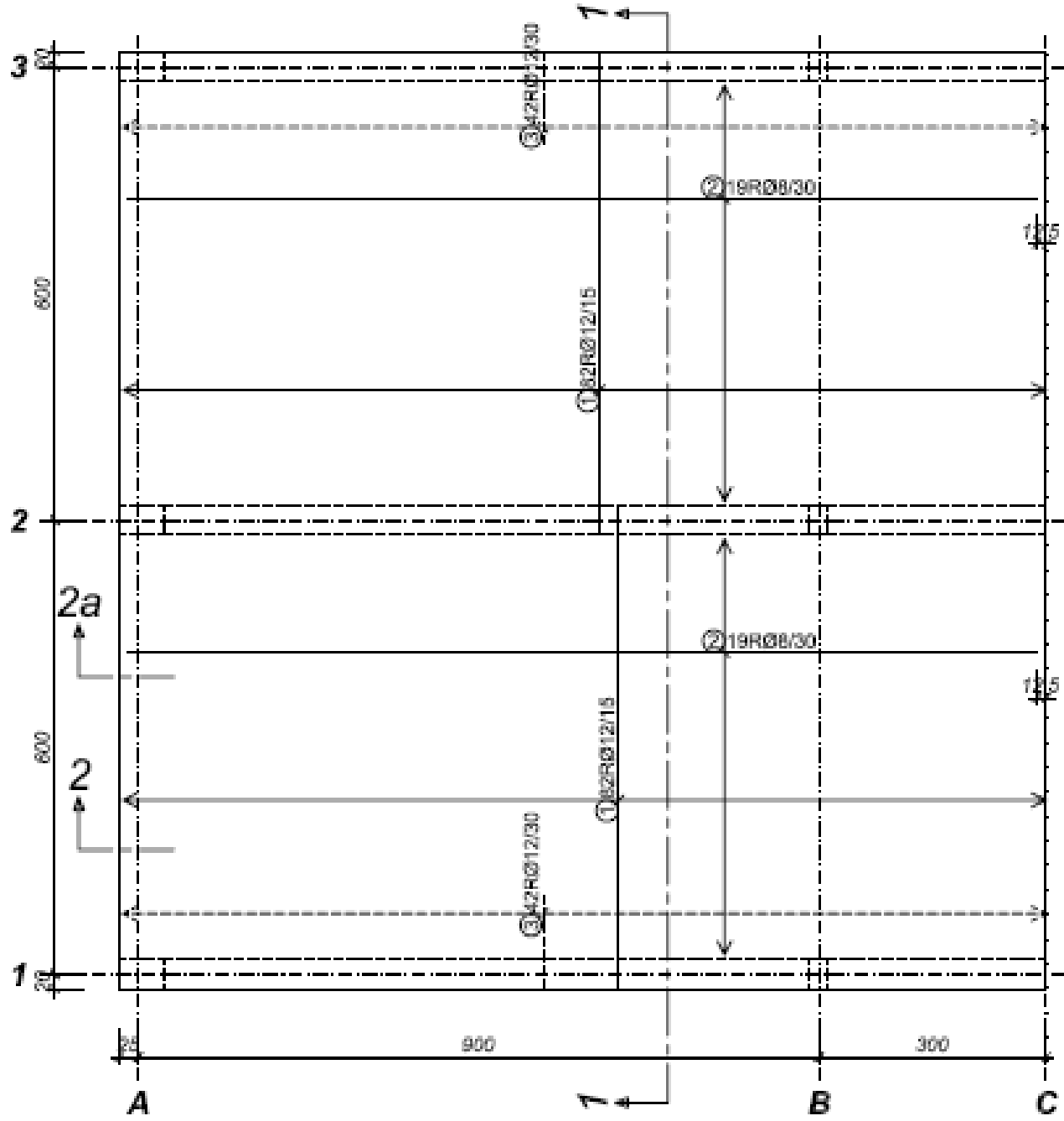

DONJA ZONA

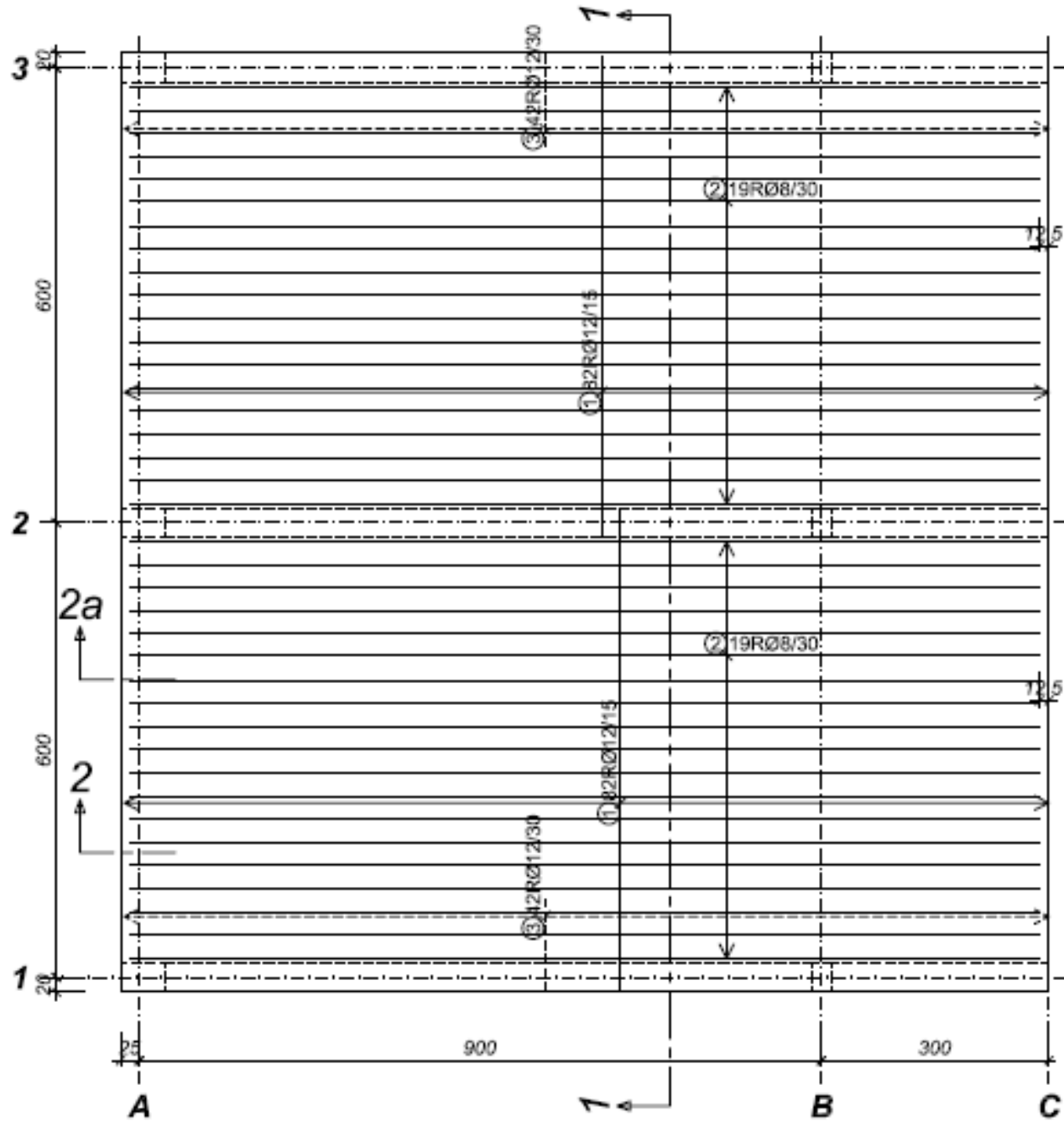

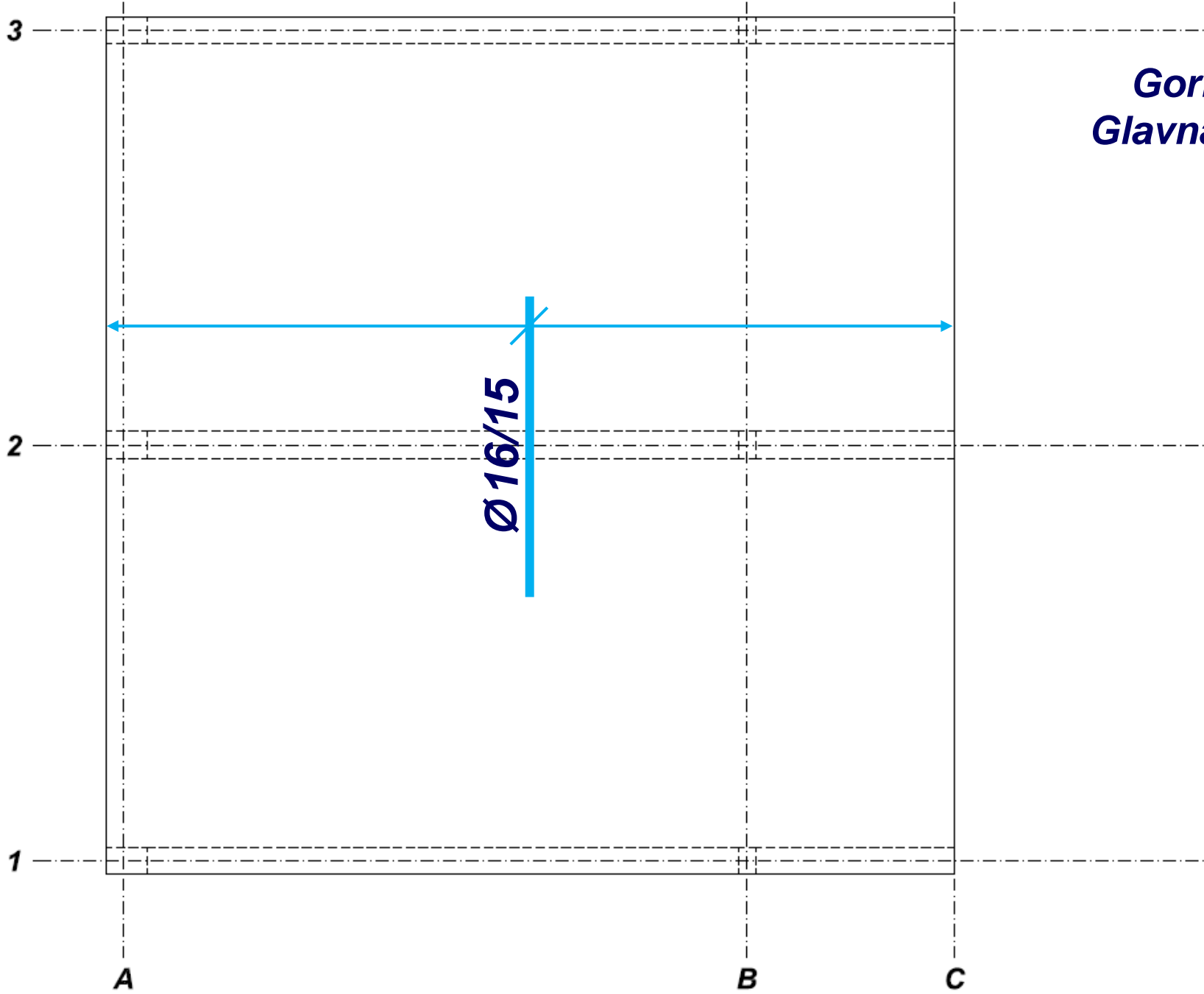

Gornja zona
Glavna armatura

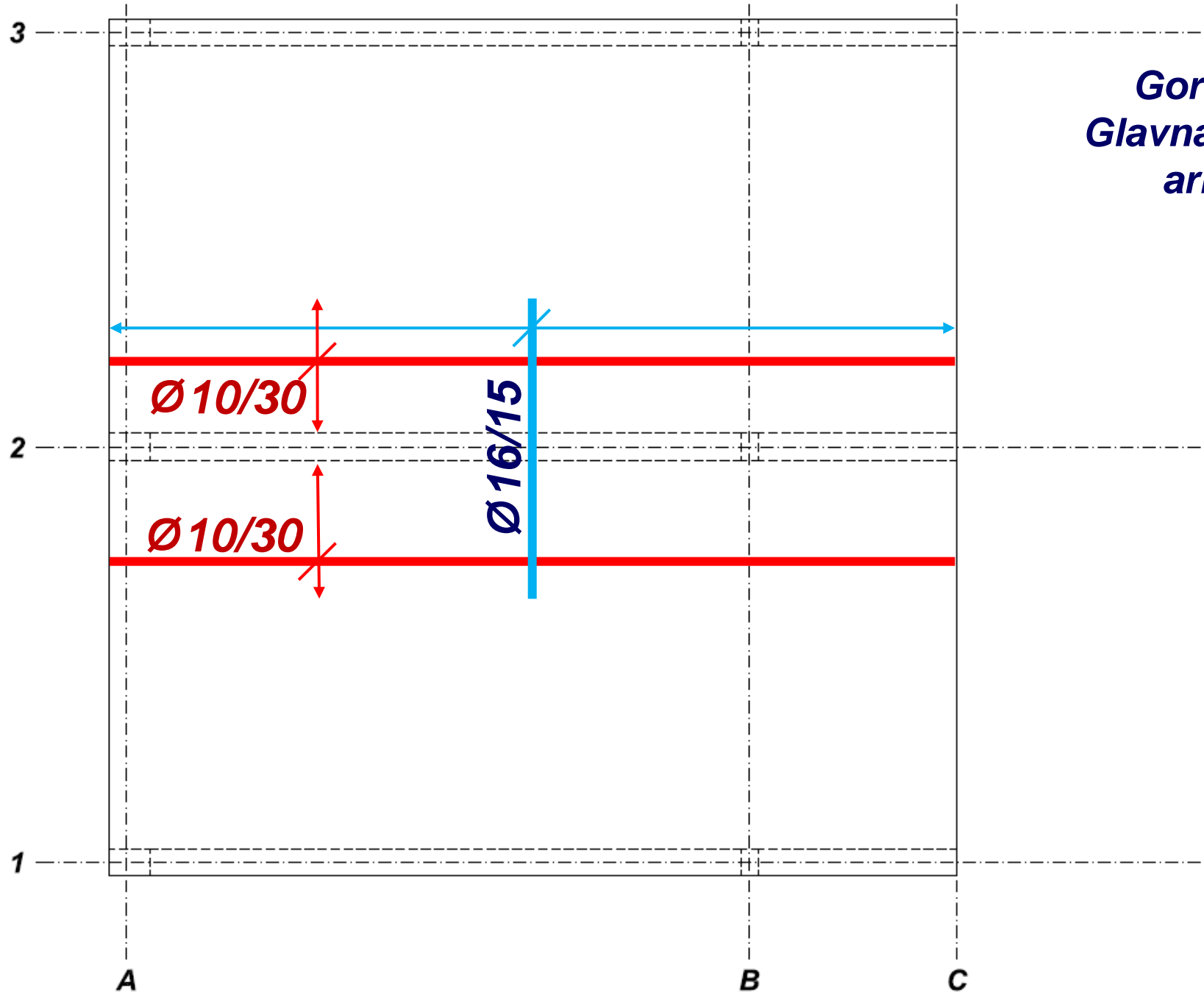

**Gornja zona
Glavna i podeona
armatura**

GORNJA ZONA

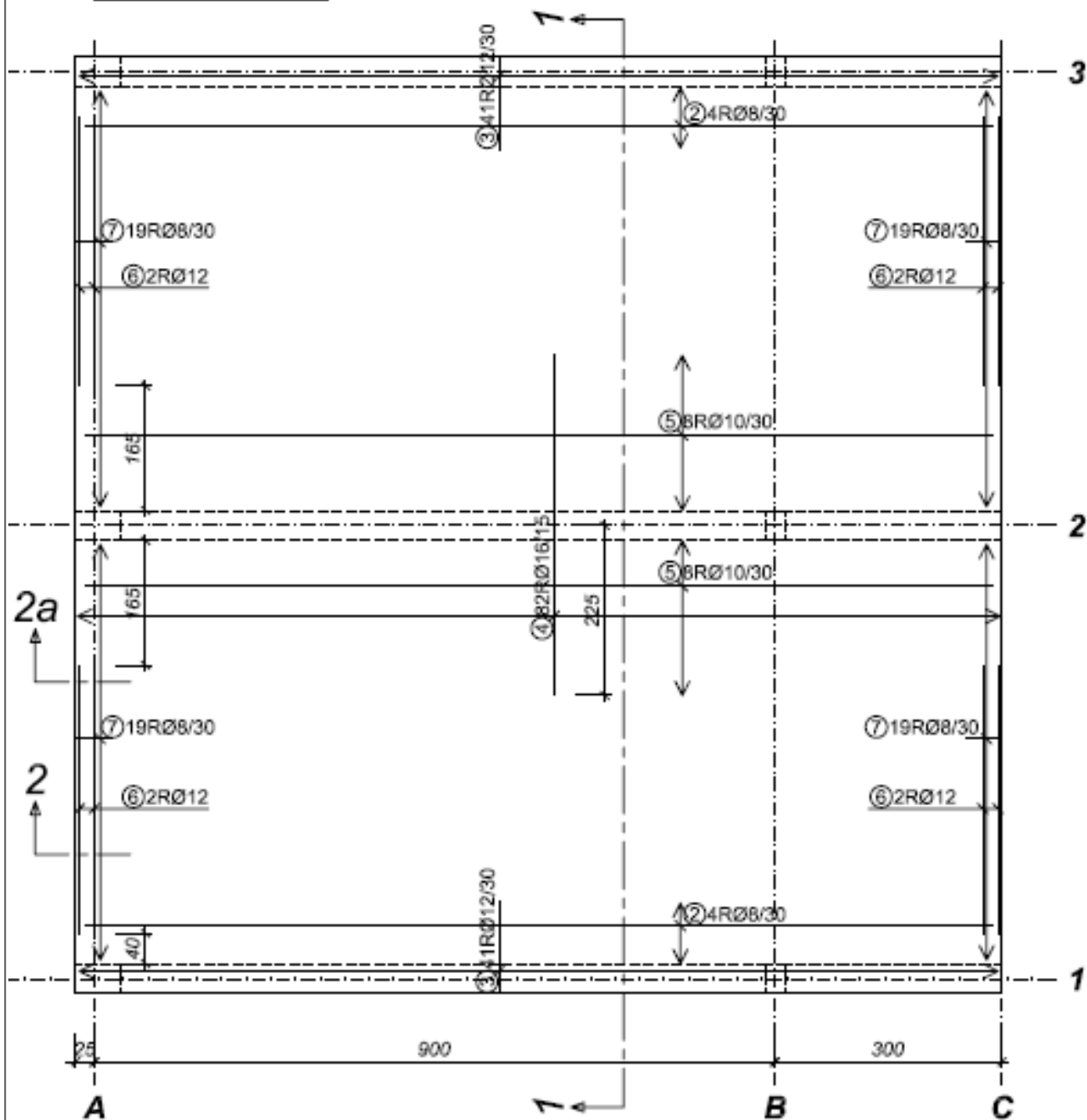

GORNJA ZONA

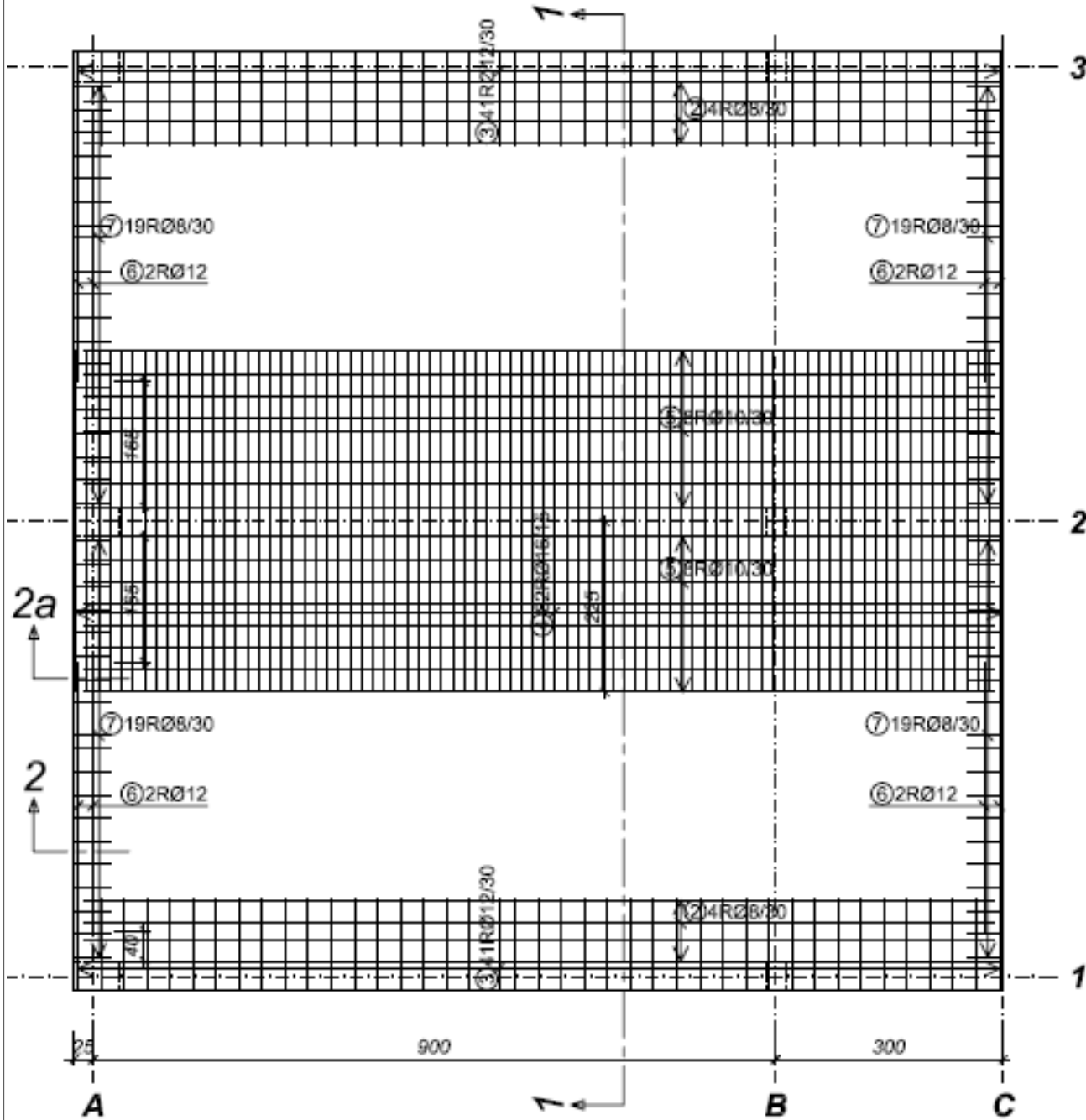

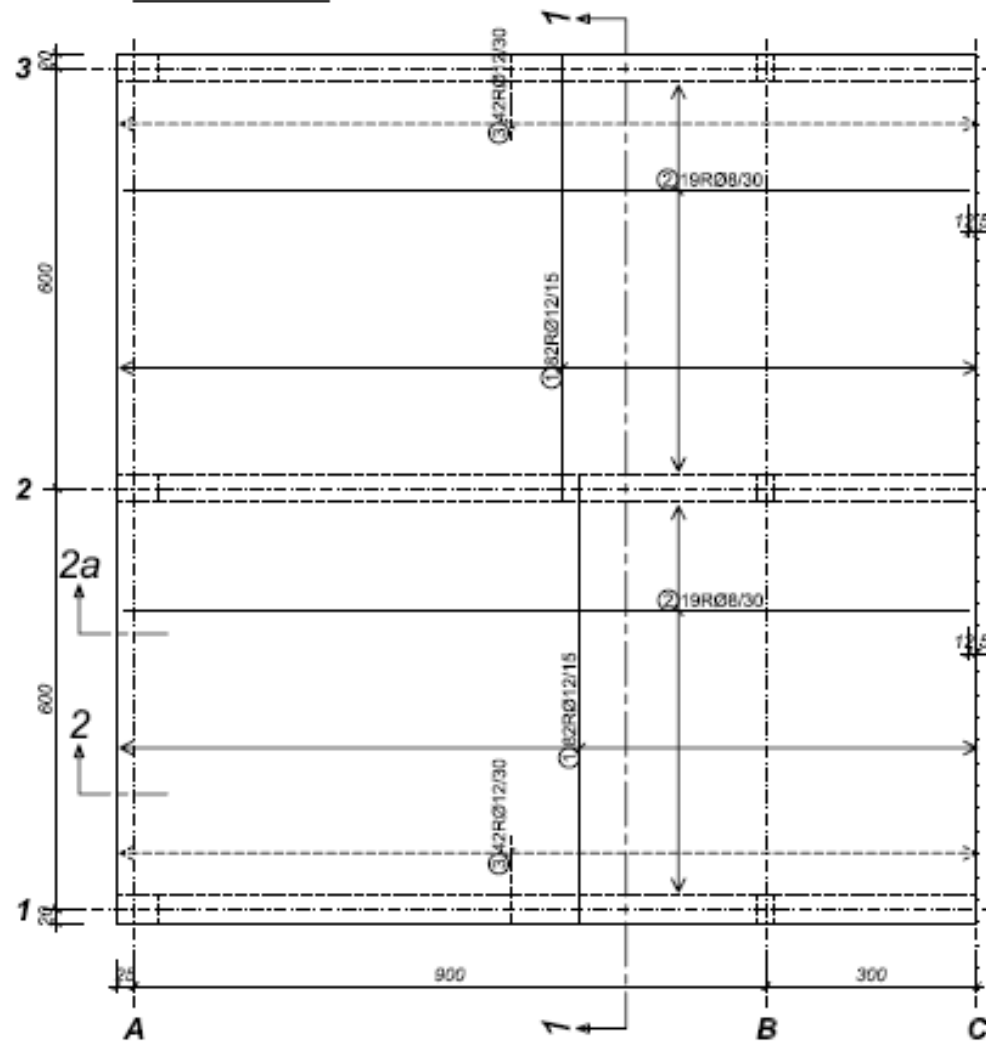
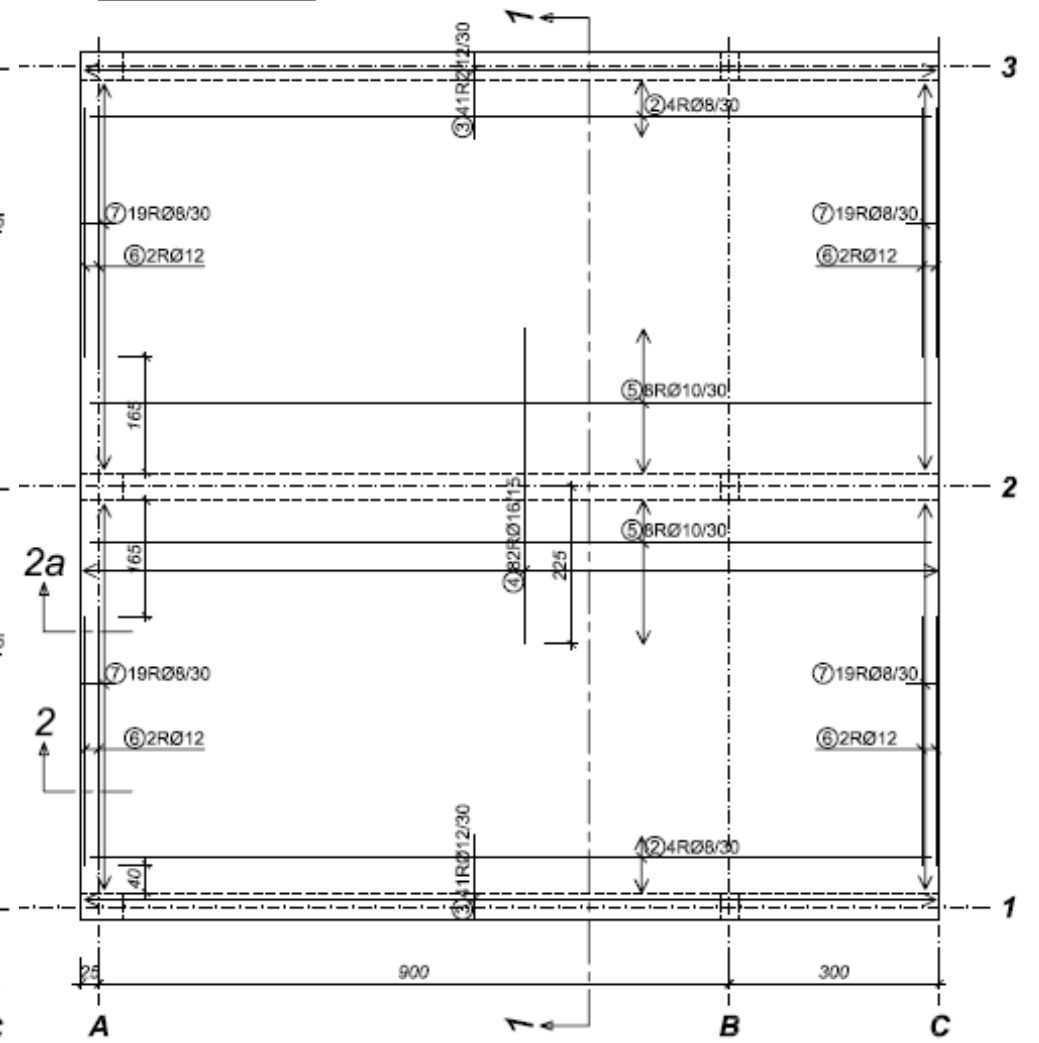
DONJA ZONA**GORNJA ZONA**

• Poprečna armatura →

• Glavna armatura →

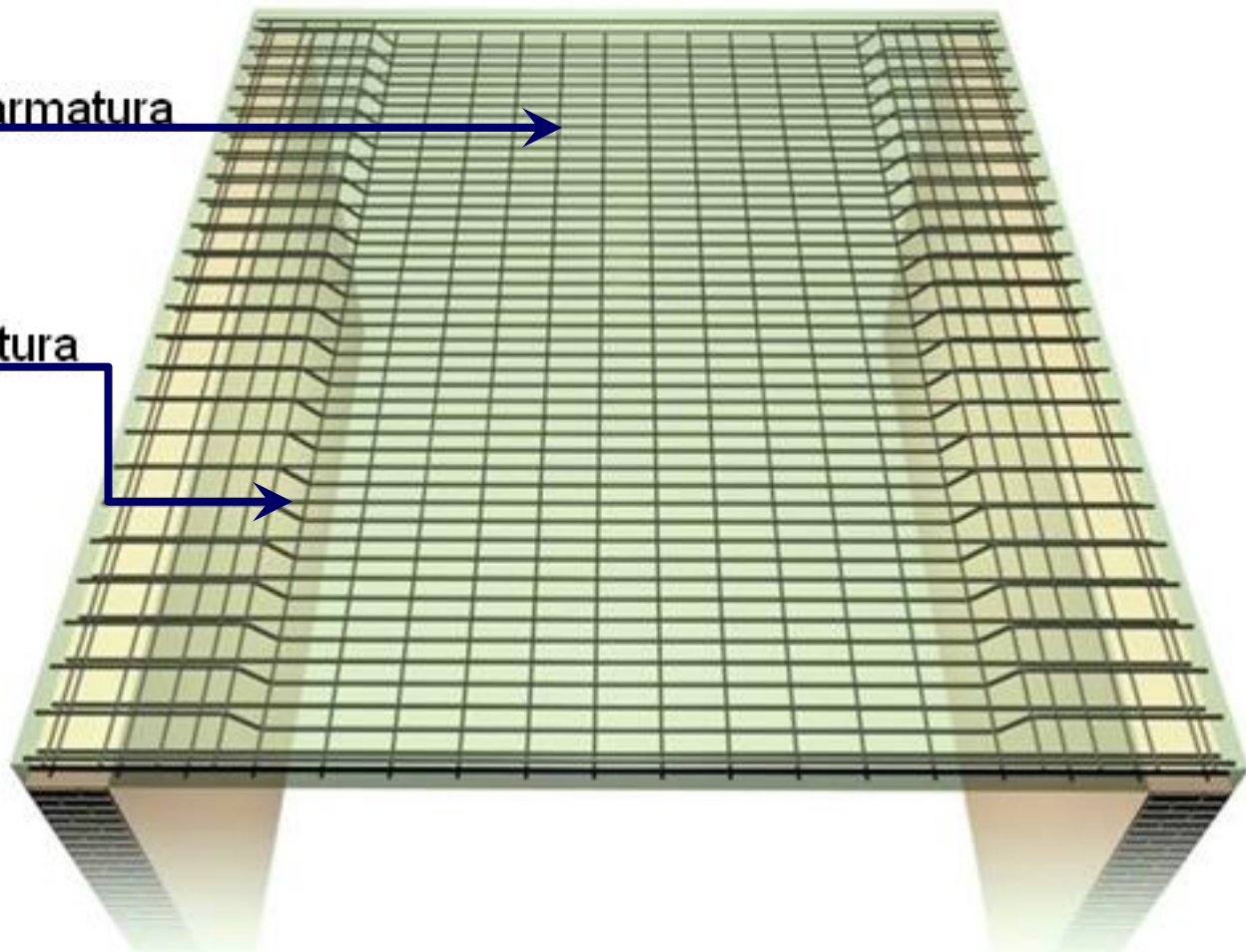

Jednako raspodeljeno opterećenje

Pritisnuta zona

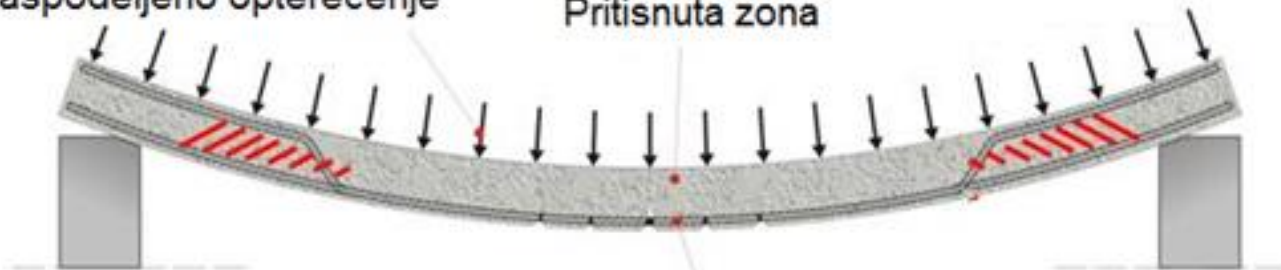

Zategnuta zona

