

Konstrukcija linije zatežućih sila

$$(\sum N = 0) \quad A_a = \frac{M_{au}}{z \cdot \sigma_v} - \frac{N_u}{\sigma_v} = \frac{1}{\sigma_v} \cdot \left(\frac{M_{au}}{\zeta \cdot h} - N_u \right)$$

$$M_{au} = M_u + N_u \cdot y_{a1} = M_u + N_u \cdot \left(\frac{d}{2} - a_1 \right)$$

$$\sigma_{a1} = \sigma_v \Rightarrow Z_{au} = A_a \cdot \sigma_{a1} = A_a \cdot \sigma_v$$

$$Z_{au} = A_a \cdot \sigma_v = \frac{M_{au}}{\zeta \cdot h} - N_u$$

Konstrukcija linije zatežućih sila

$$\left. \begin{array}{l} h = h_{min.} = const. \\ \zeta \approx 0.9 \end{array} \right\} \Rightarrow z \approx 0.9 \times h_{min.}$$

$$Z_{au} = A_a \times \sigma_v \approx \frac{M_{au}}{0.9 \times h_{min.}} - N_u$$

čisto savijanje: $N_u = 0 \Rightarrow M_{au} = M_u$

$$Z_{au} = A_a \times \sigma_v \approx \frac{M_u}{0.9 \times h_{min.}}$$

Reakcije oslonaca

$$g = 30 \text{ kN/m}$$

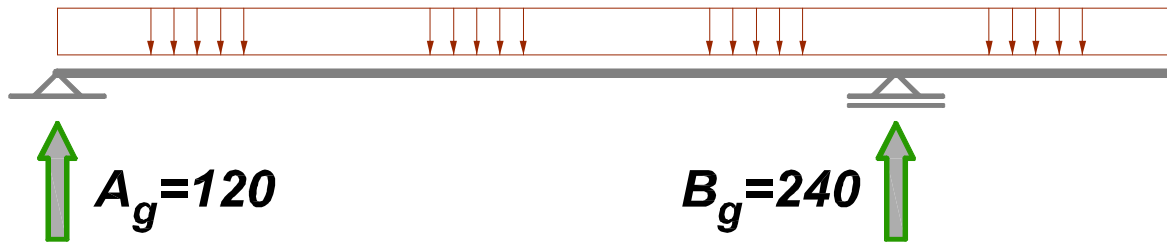

$$B_g = (30 \times 12^2 / 2) / 9 = 240 \text{ kN}$$

$$A_g = 30 \times 12 - 240 = 120 \text{ kN}$$

$$p_1 = 40 \text{ kN/m}$$

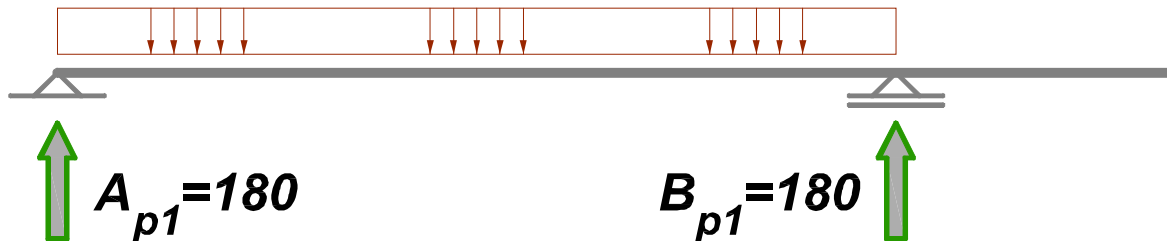

$$A_{p1} = B_{p1} = 40 \times 9 / 2 = 180 \text{ kN}$$

$$p_2 = 60 \text{ kN/m}$$

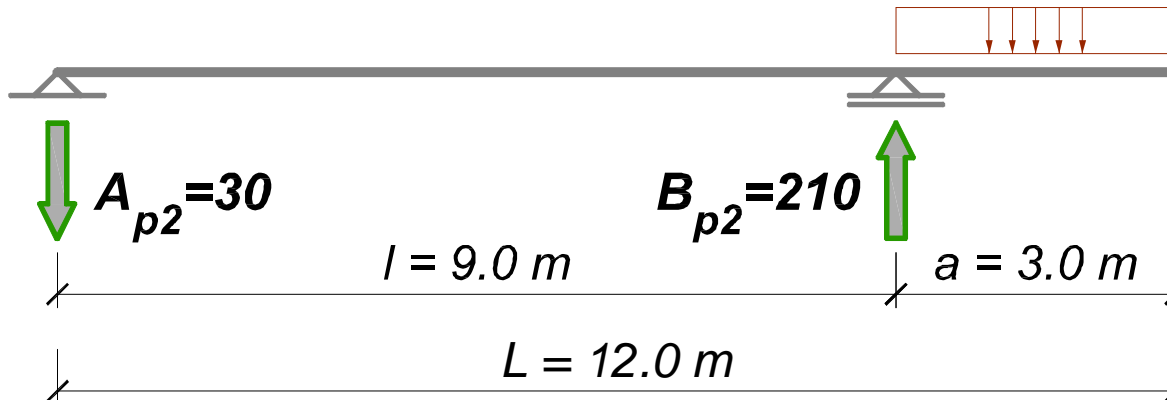

$$B_{p2} = [(60 \times 3 \times (9 + 3/2))] / 9$$

$$B_{p2} = 210 \text{ kN}$$

$$A_{p2} = 60 \times 3 - 210 = -30 \text{ kN}$$

Dijagrami momenata savijanja

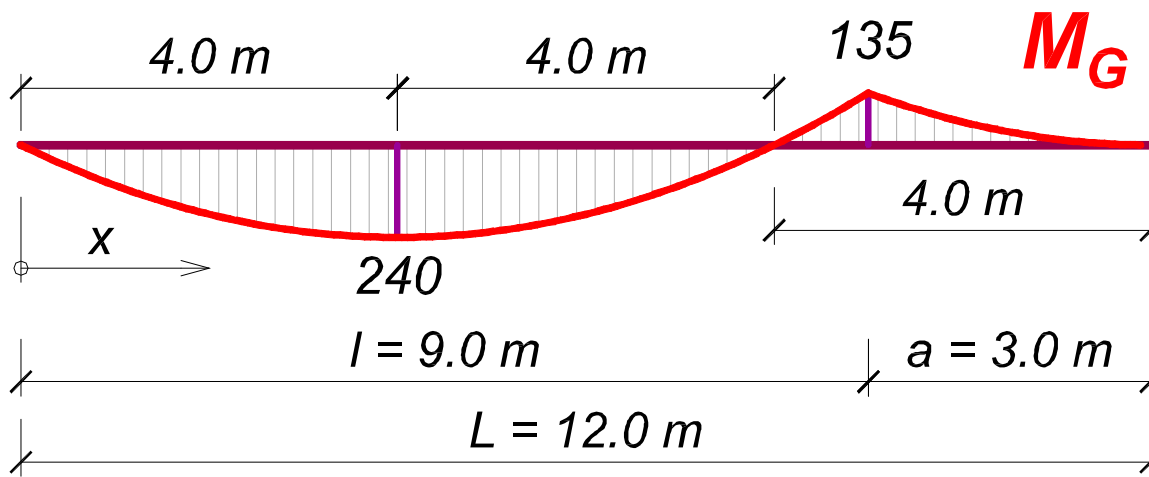

oslonac:

$$M_g = 30 \times 3^2 / 2 = 135\text{ kNm}$$

polje:

$$x_{\max} = 120 / 30 = 4.0\text{ m}$$

$$M_g = 120 \times 4 - 30 \times 4^2 / 2$$

$$M_g = 240\text{ kNm}$$

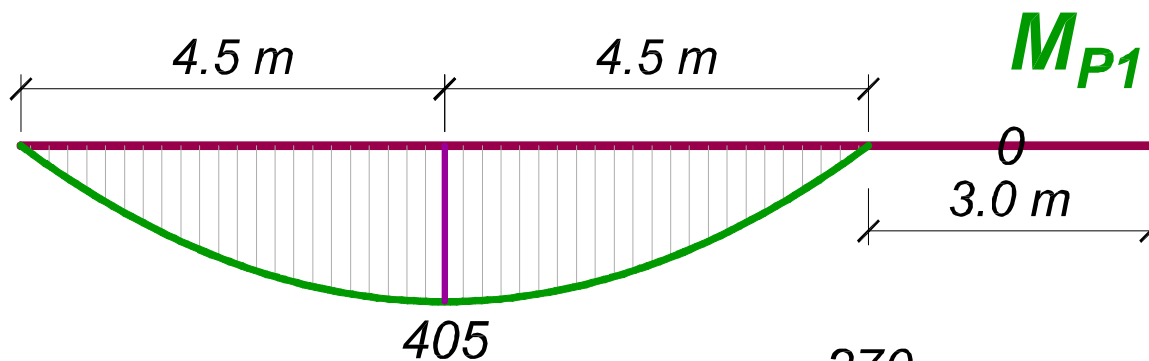

polje:

$$M_{p1} = 40 \times 9^2 / 2 = 405\text{ kNm}$$

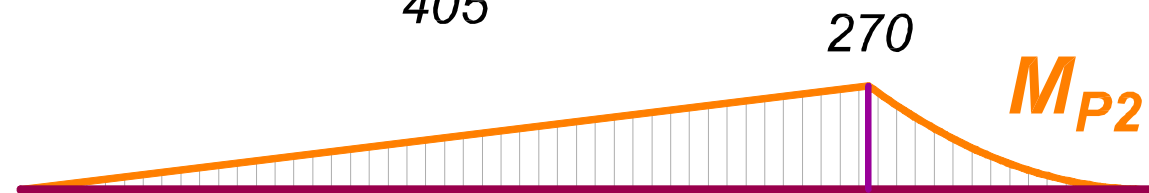

oslonac:

$$M_{p2} = 60 \times 3^2 / 2 = 270\text{ kNm}$$

Anvelopa momenata savijanja

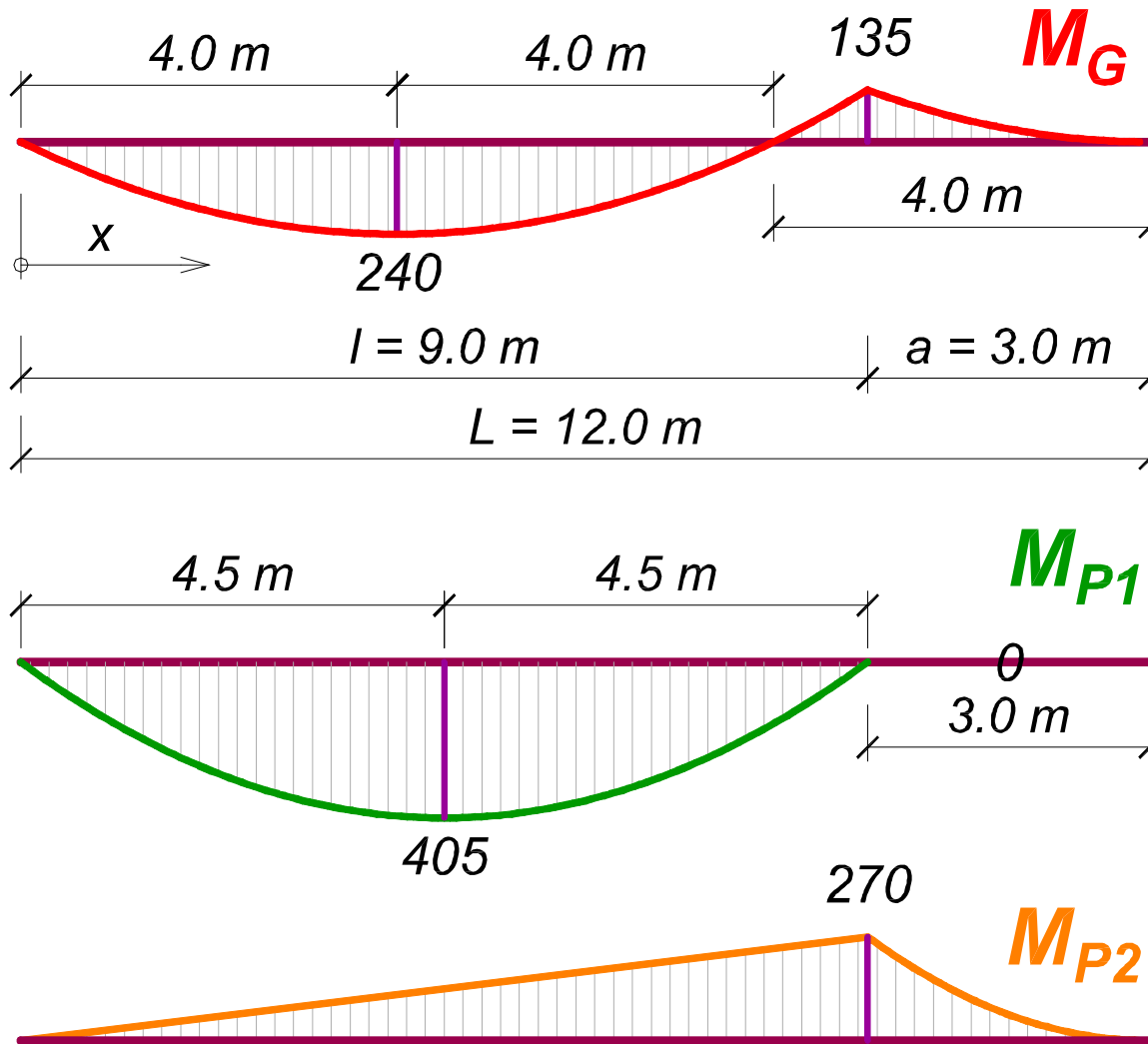

$$1.6 \times G$$

$$1.6 \times G + 1.8 \times P_1 \quad \leftarrow$$

$$1.6 \times G + 1.8 \times P_2 \quad \leftarrow$$

$$1.6 \times G + 1.8 \times (P_1 + P_2)$$

$$\cancel{1.0 \times G}$$

$$1.0 \times G + 1.8 \times P_1 \quad \leftarrow$$

$$1.0 \times G + 1.8 \times P_2 \quad \leftarrow$$

$$1.0 \times G + 1.8 \times (P_1 + P_2)$$

Anvelopa momenata savijanja

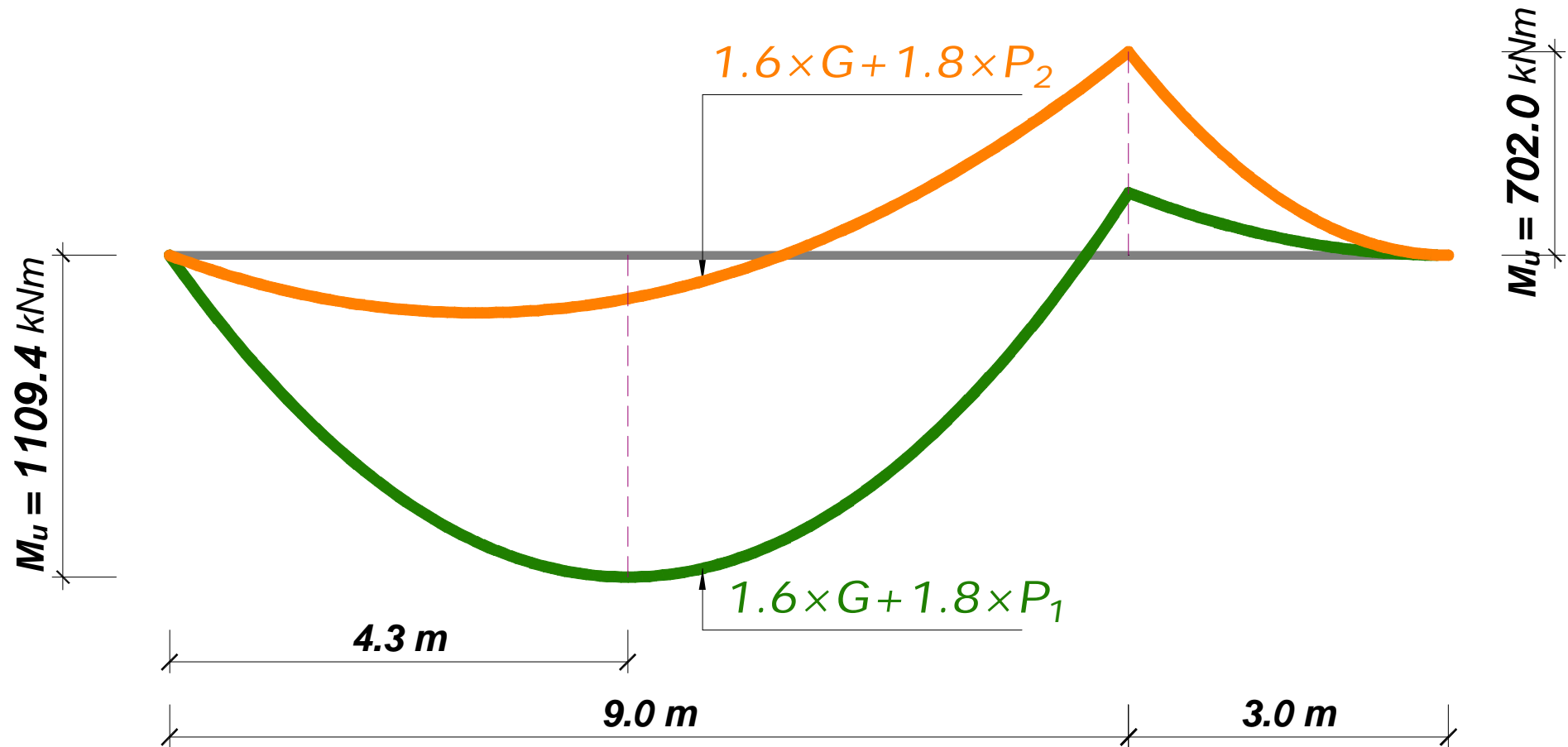

Anvelopa momenata savijanja

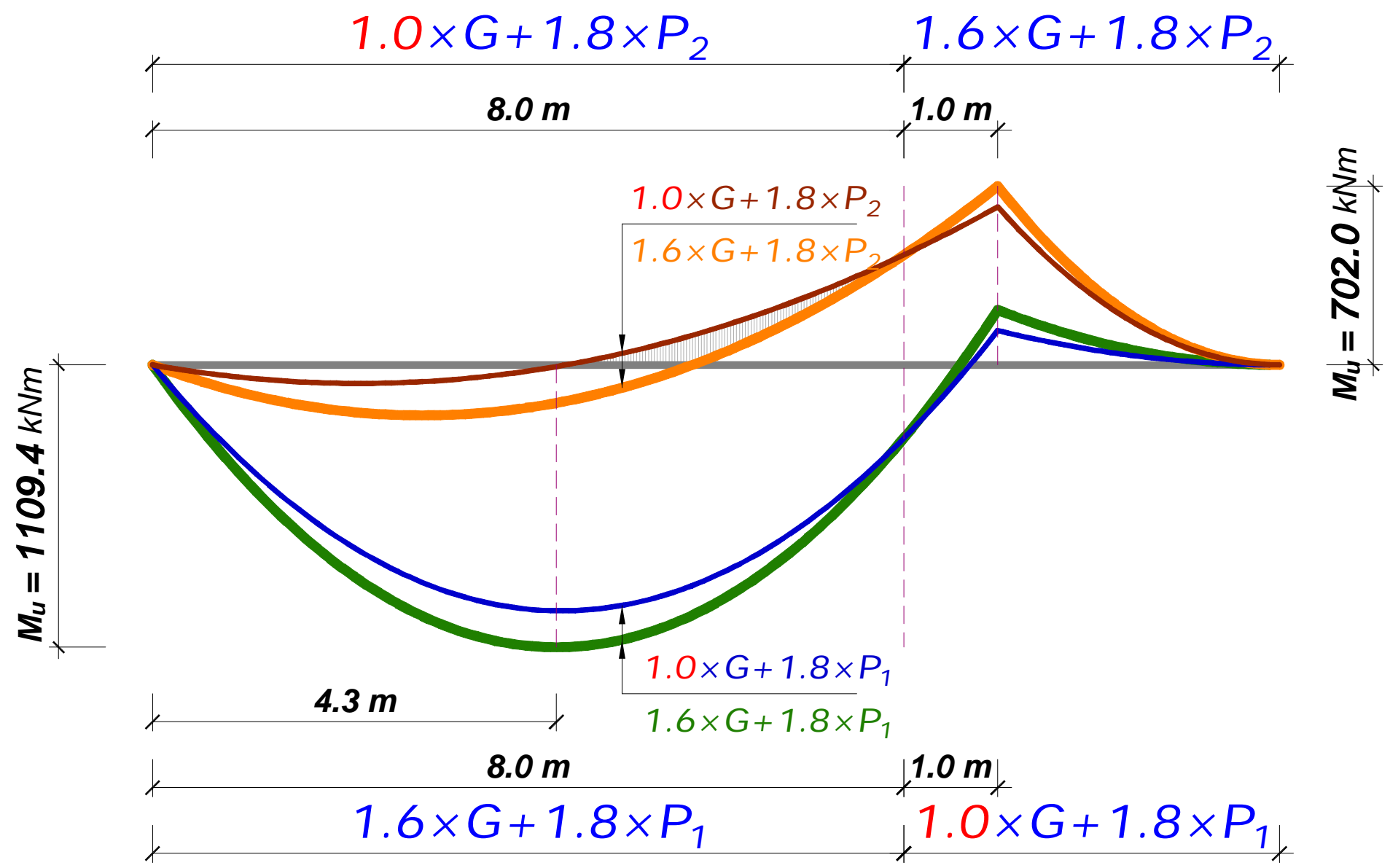

Anvelopa momenata savijanja

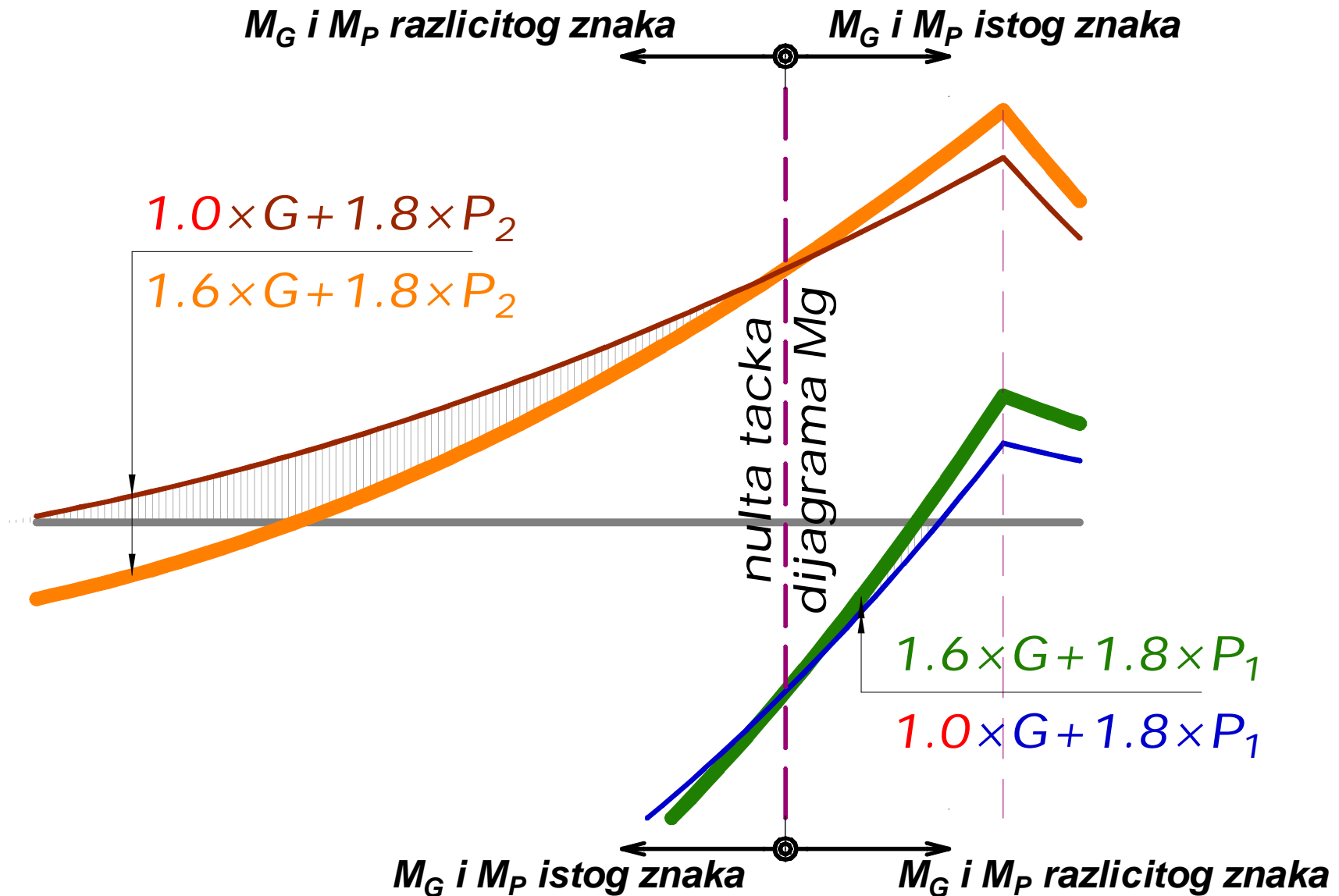

Anvelopa momenata savijanja

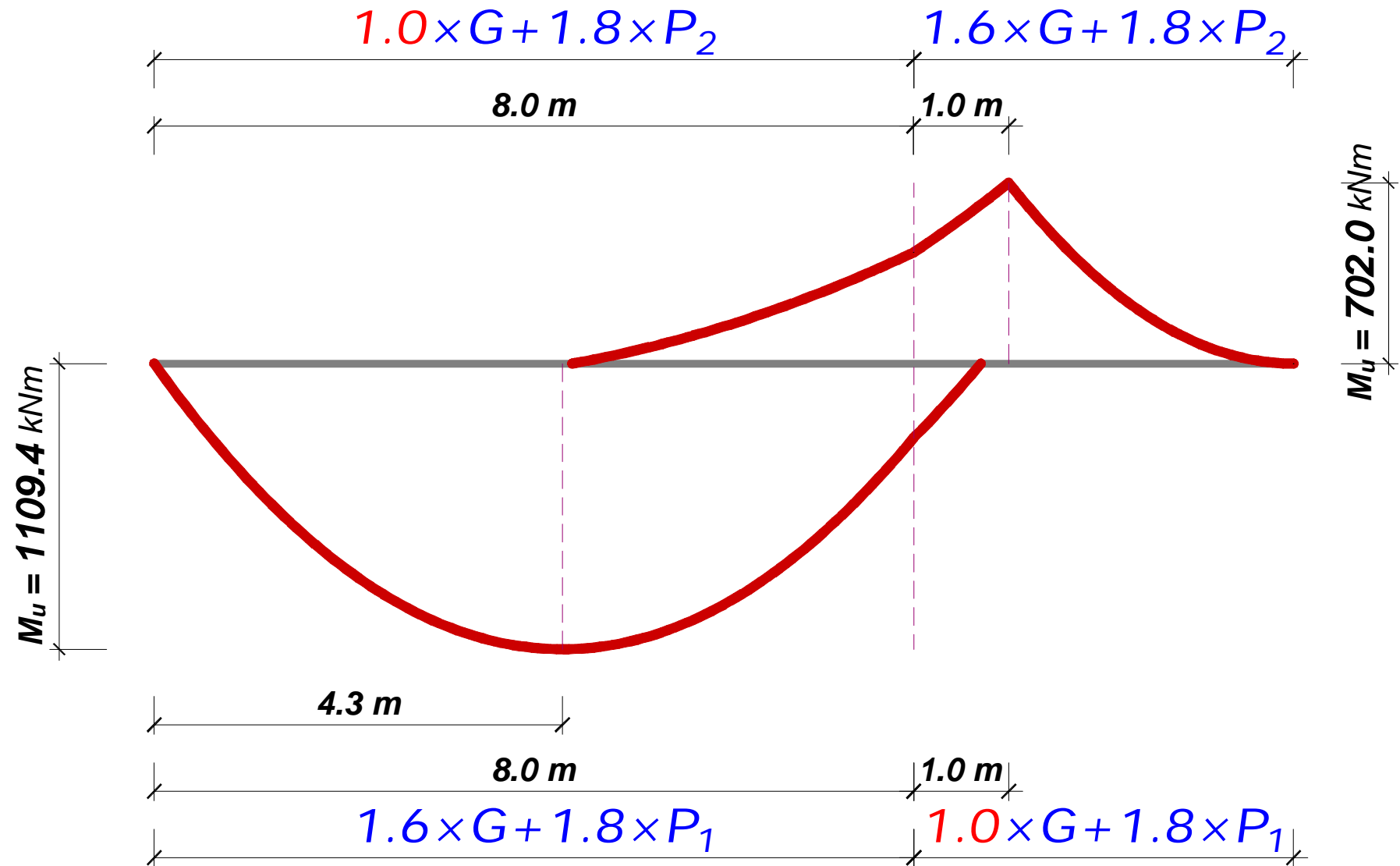

Dimenzionisanje - presek u polju

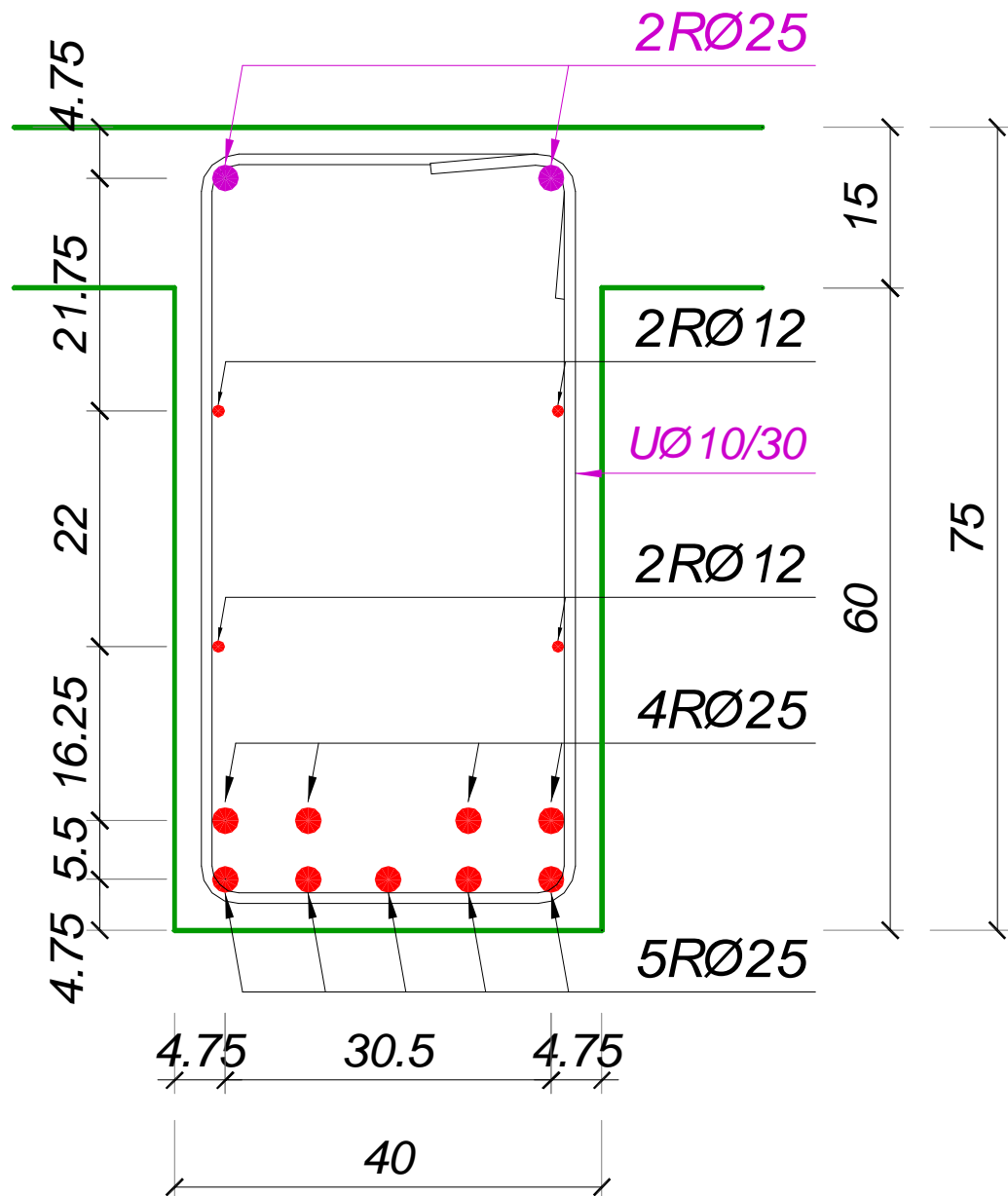

$$a' = 2.5 + 1.0 + 2.5/2 = 4.75 \text{ cm}$$

$$a'' = 4.75 + 3.0 + 2.5 = 10.25 \text{ cm}$$

$$a_1 = (5 \times 4.75 + 4 \times 10.25) / 9$$

$$a_1 = 7.19 \text{ cm}$$

$$h = 75 - 7.19 = 67.81 \text{ cm}$$

$$h \approx 68 \text{ cm} = h_{\text{rač.}}$$

Dimenzionisanje - oslonac

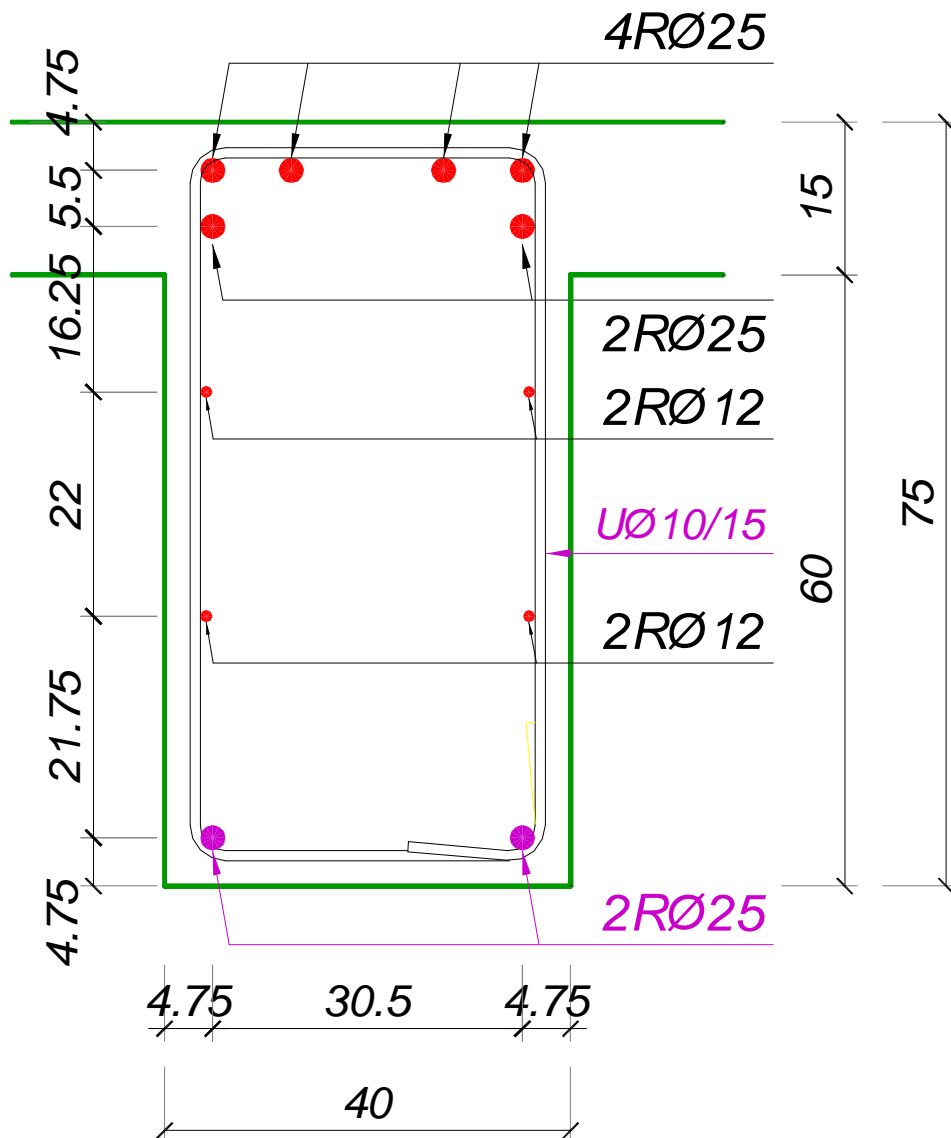

$$a' = 2.5 + 1.0 + 2.5/2 = 4.75 \text{ cm}$$

$$a'' = 4.75 + 3.0 + 2.5 = 10.25 \text{ cm}$$

$$a_1 = (4 \times 4.75 + 2 \times 10.25) / 6$$

$$a_1 = 6.58 \text{ cm}$$

$$h = 75 - 6.58 = 68.42 \text{ cm}$$

$$h \approx 68 \text{ cm} = h_{\text{rač.}}$$

Analitički izrazi za momente savijanja

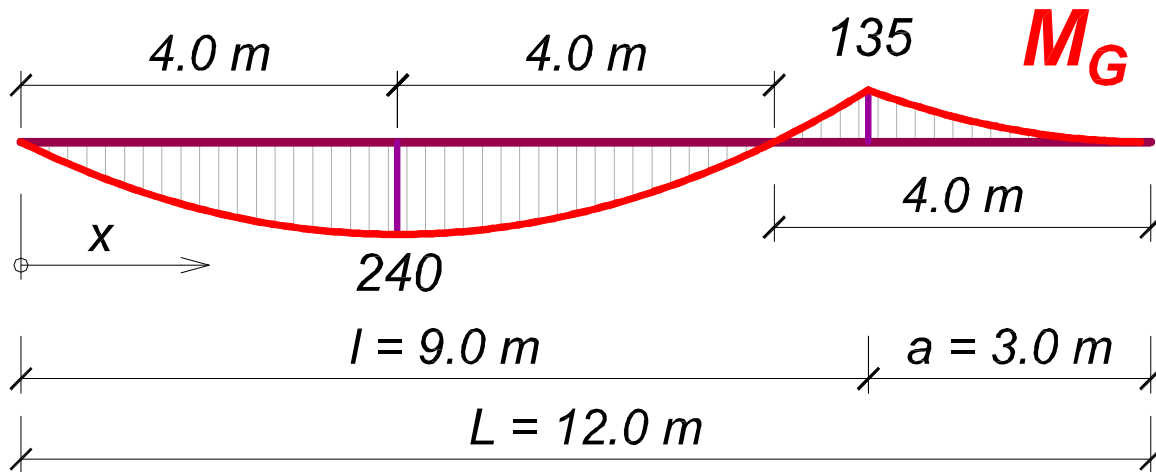

$$x \leq l: M_g = A_g \cdot x - \frac{g \cdot x^2}{2}$$

$$x \geq l: M_g = -\frac{g \cdot (L - x)^2}{2}$$

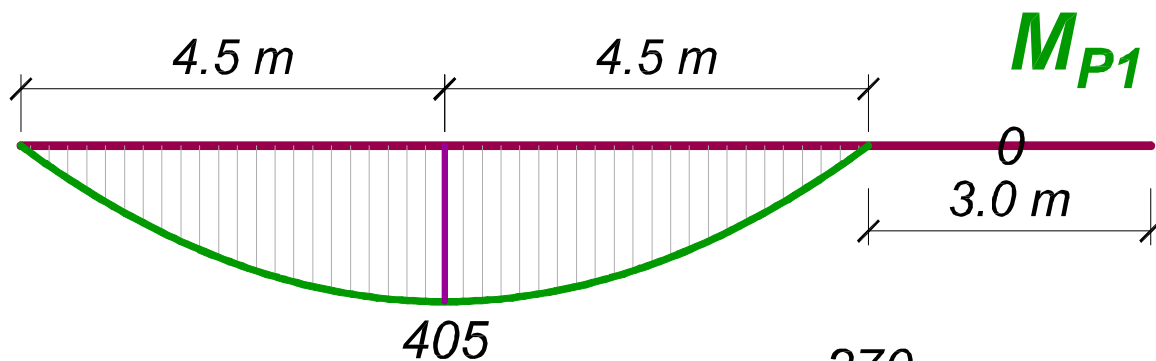

$$x \leq l: M_{p1} = A_{p1} \cdot x - \frac{p_1 \cdot x^2}{2}$$

$$x \geq l: M_{p1} = 0$$

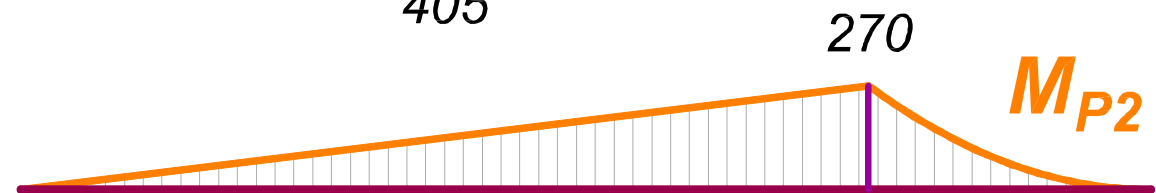

$$x \leq l: M_{p2} = A_{p2} \cdot x$$

$$x \geq l: M_{p2} = -\frac{p_2 \cdot (L - x)^2}{2}$$

Anvelopa momenata savijanja - Excel

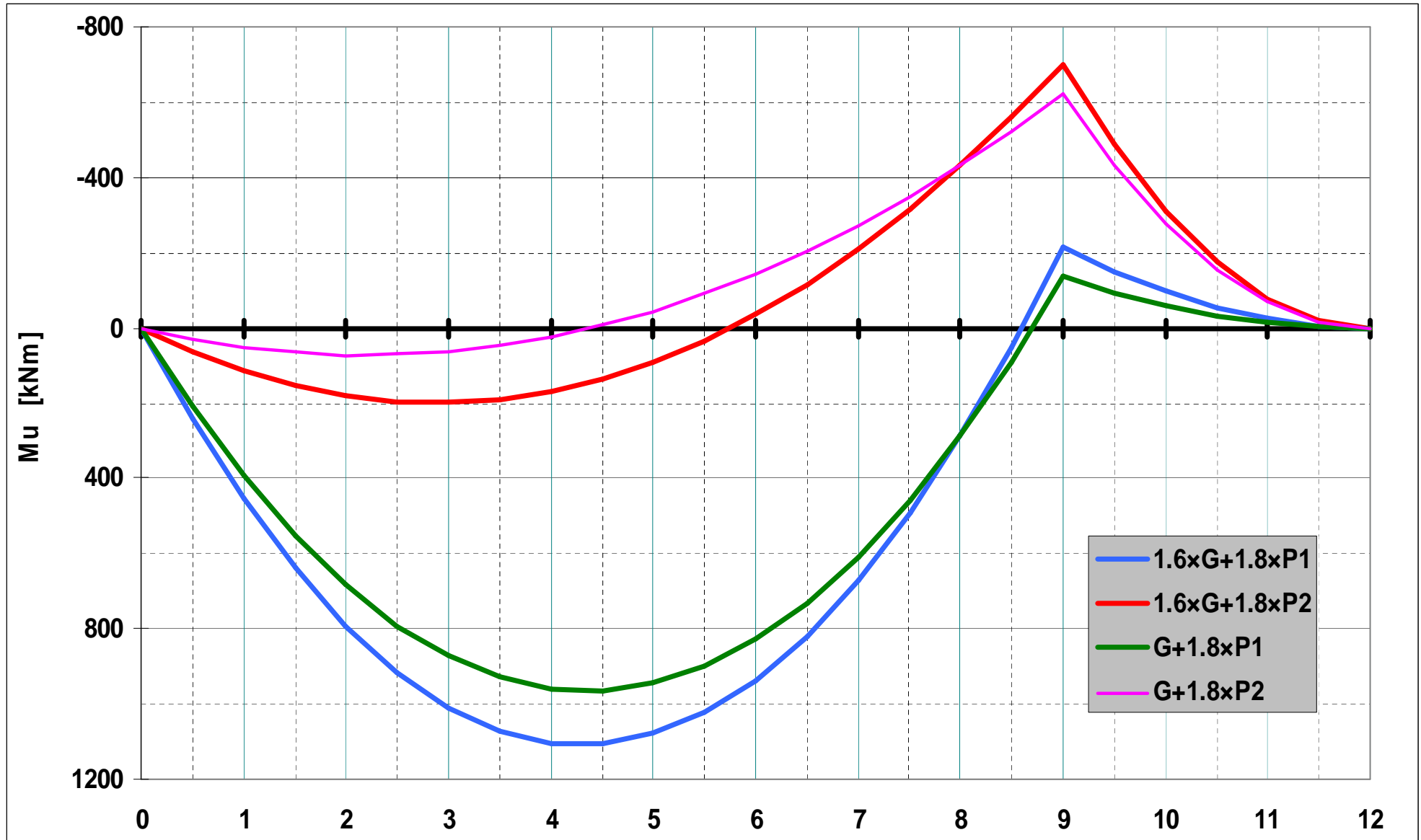

M/z linija

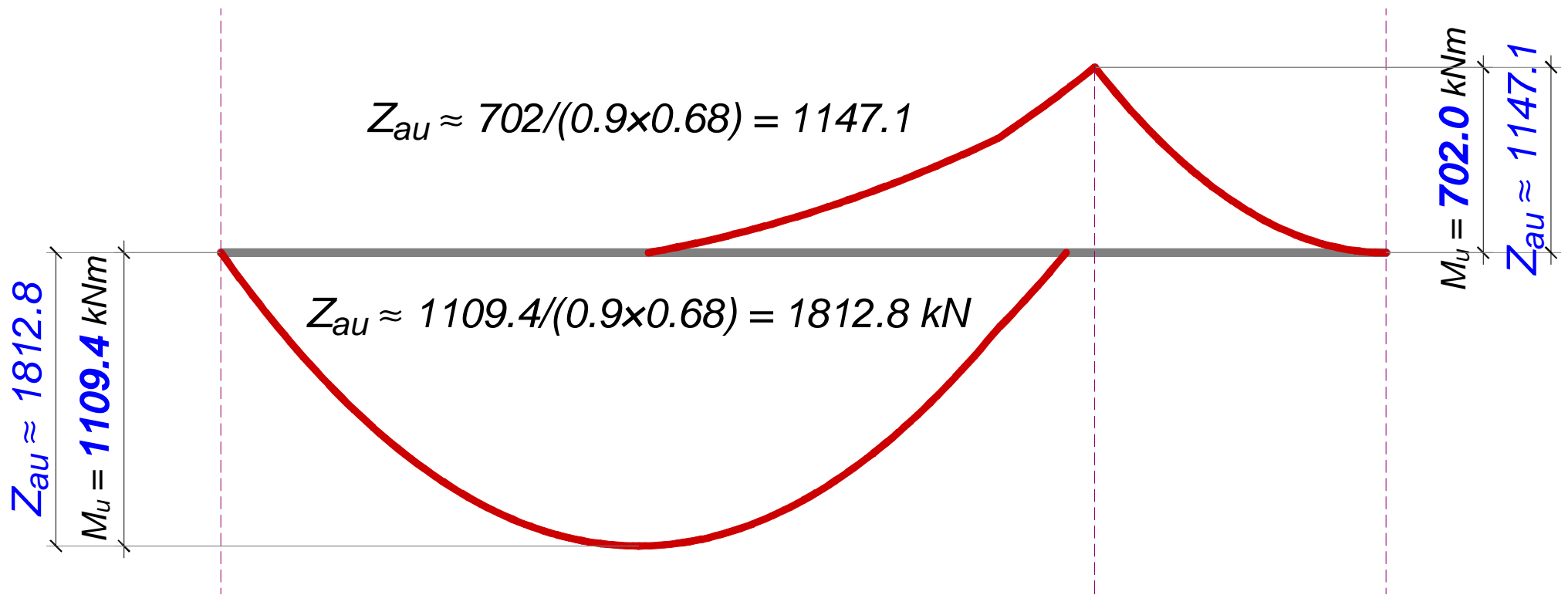

$$Z_{au} = A_a \times \sigma_v \approx \frac{M_{au}}{0.9 \times h_{min.}} - N_u = \frac{M_u}{0.9 \times h_{min.}}$$

Opt. 1: g

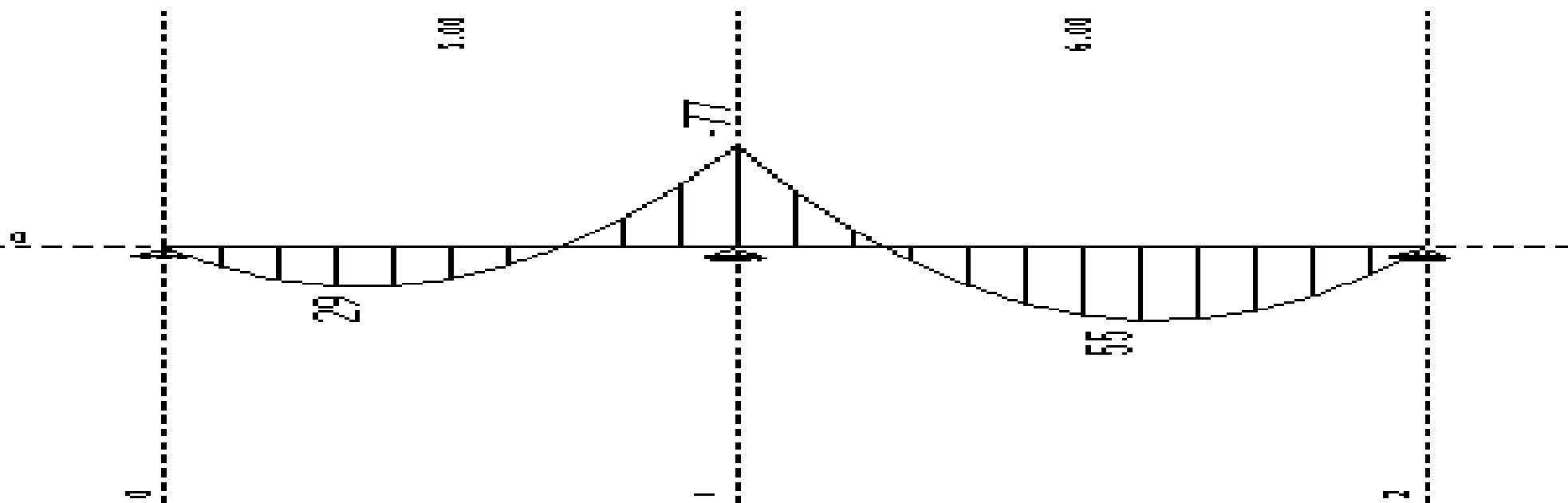

Uticaji u gredi: max M3= 55 / min M3= -77 kNm

Opt. 2: p1

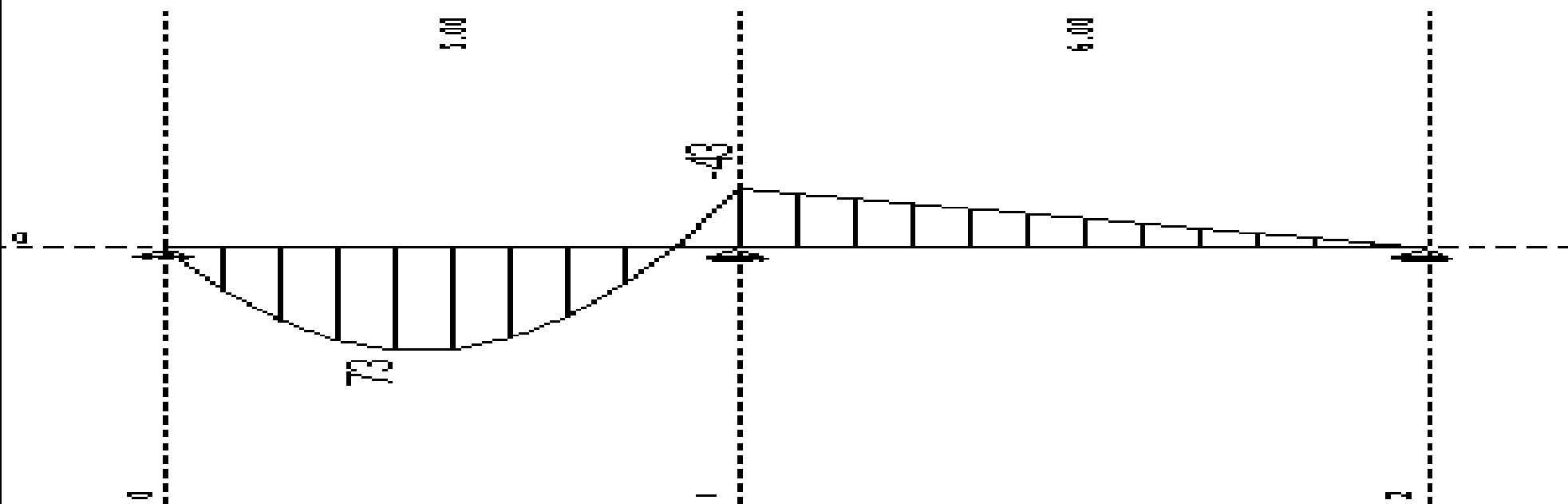

Uticaji u gredi: max M3= 73 / min M3= -43 kNm

Opt. 3: p2

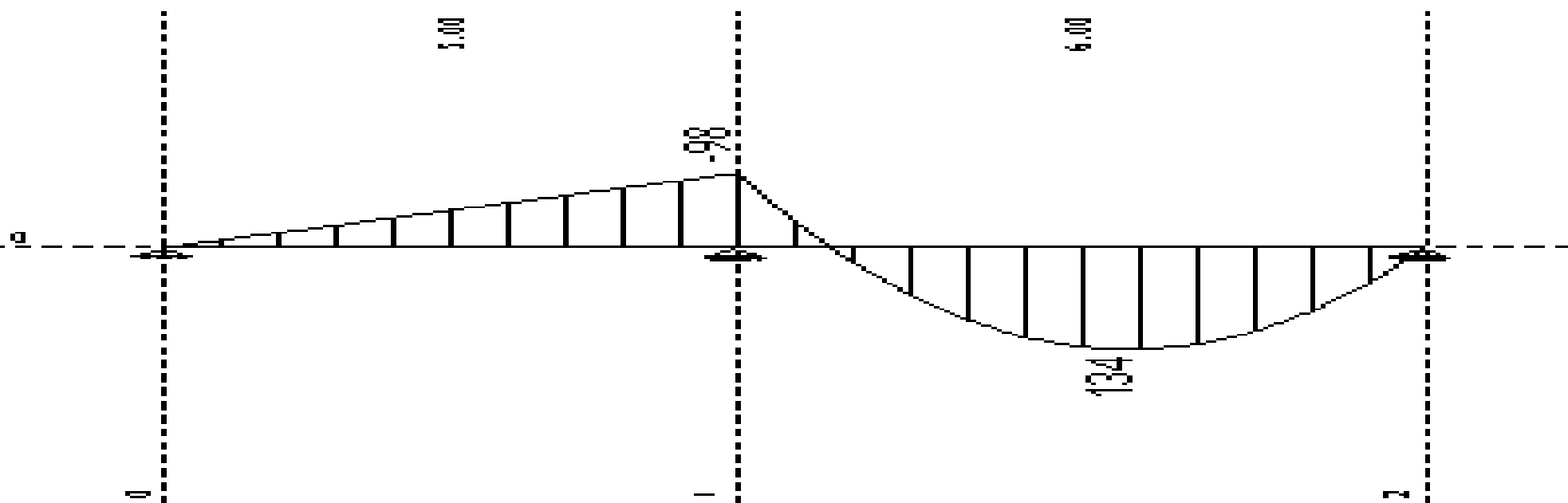

Uticaji u gredi: max M3= 134 / min M3= -98 kNm

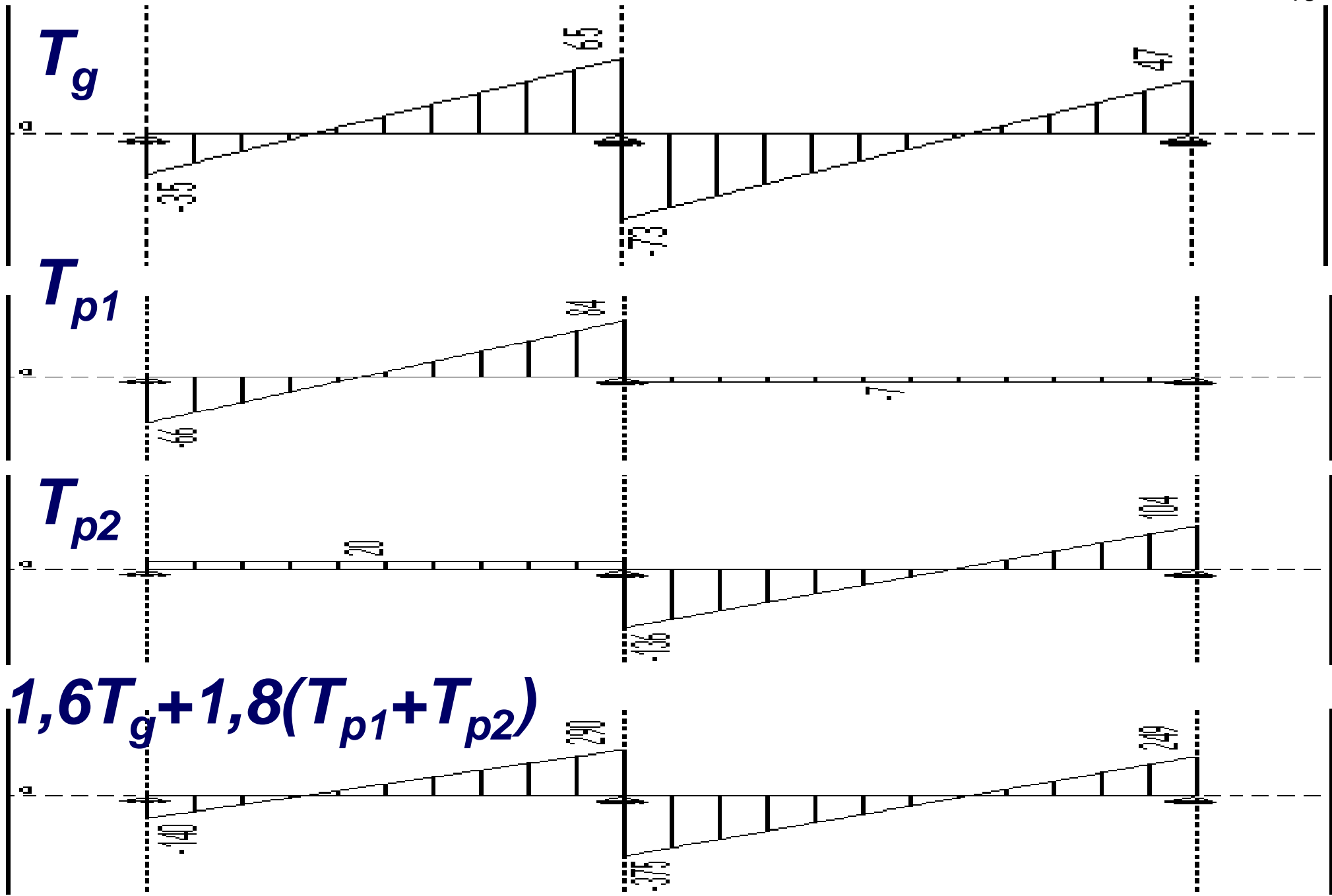

Opt. 5: 1.6g+1.8 (p1+p2)

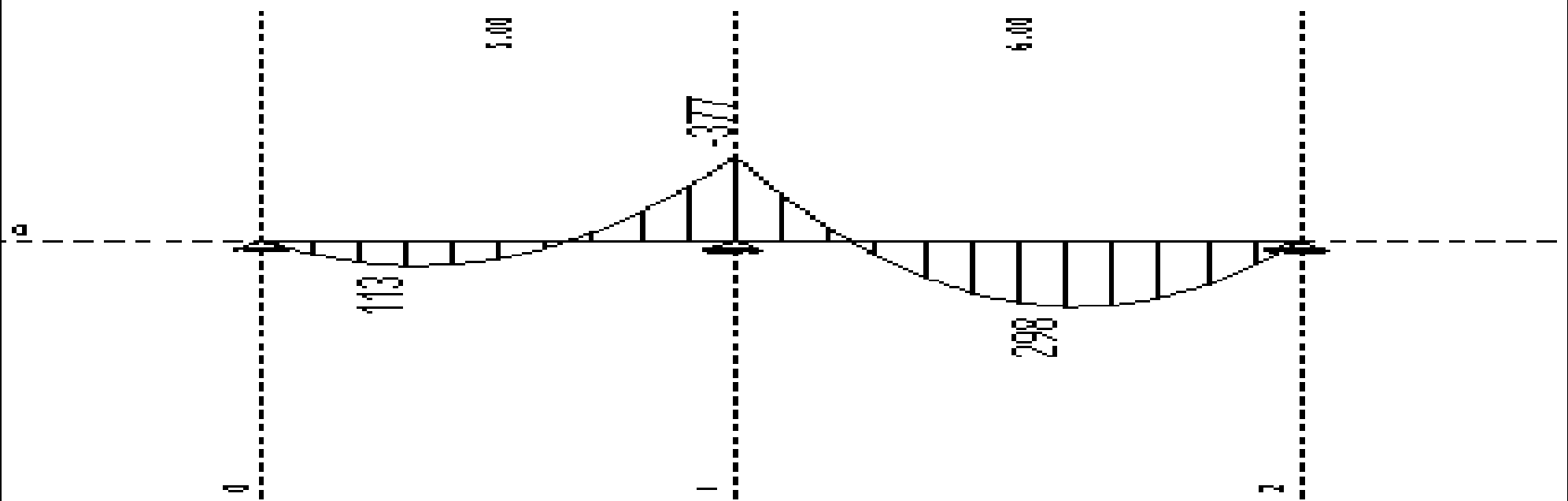

Uticaji u gredi: max M3= 298 / min M3= -377 kNm

M/z linija

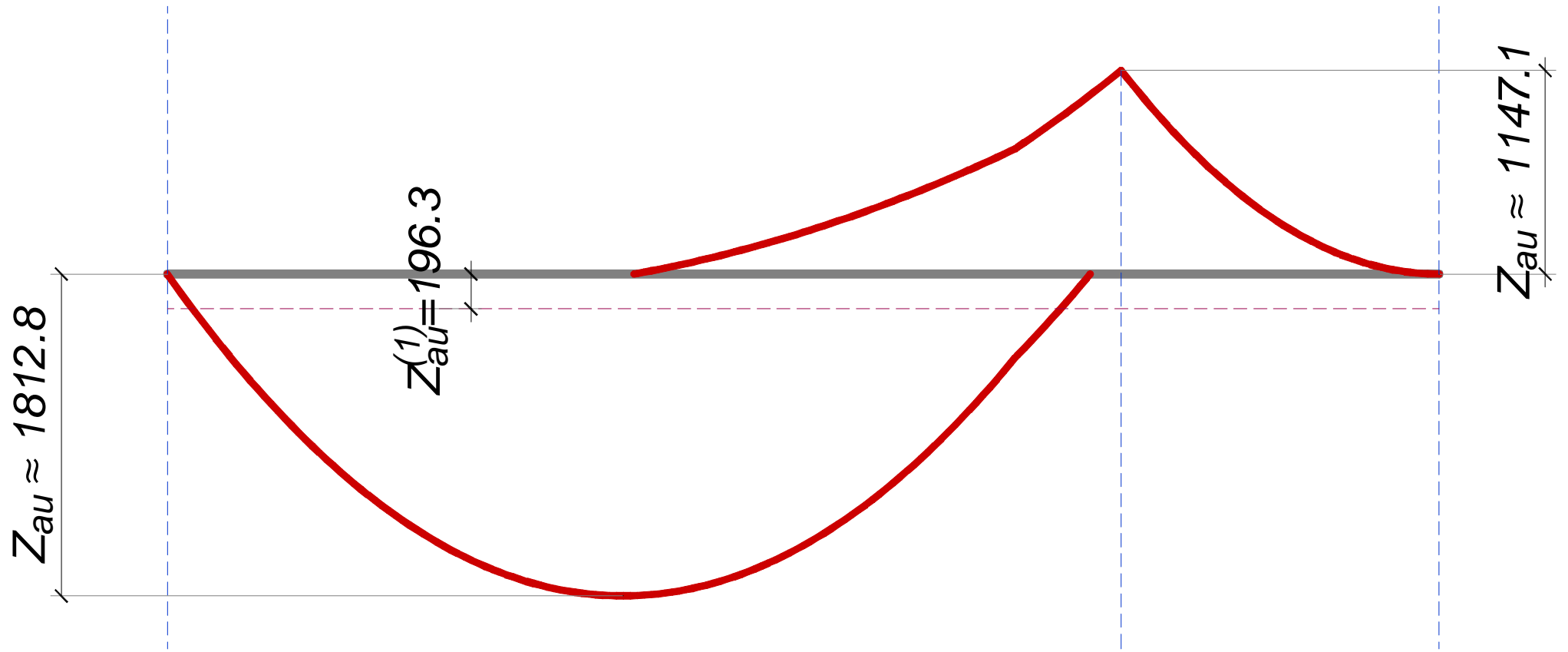

$$Z_{au}^{(1)} = a_a^{(1)} \times \sigma_v = 4.91 \times 40 = 196.3 \text{ kN}$$

Linija zatežućih sila

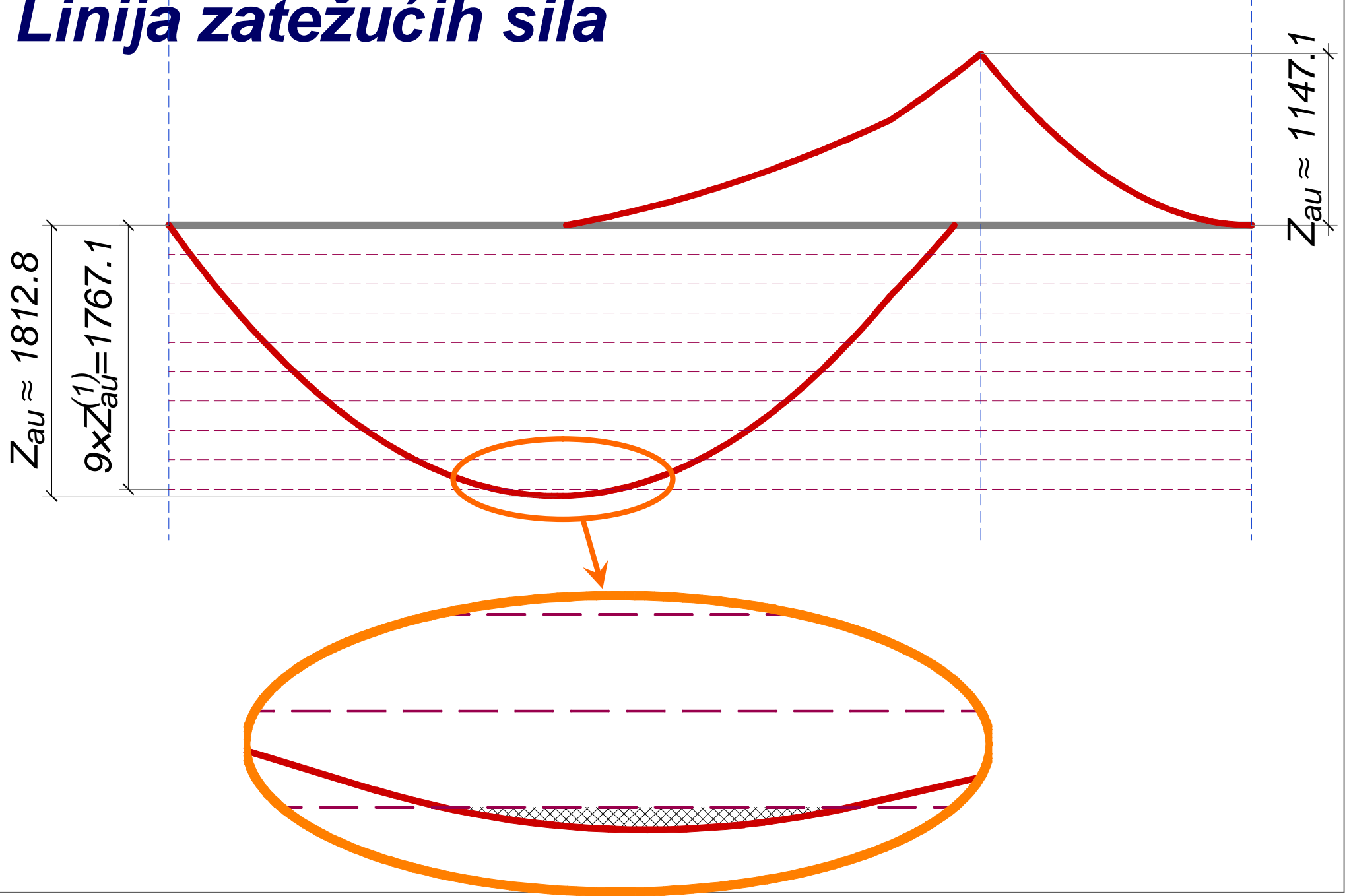

M/z linija

$$z = 0.894$$

$$A_{a,potr.} = 28.85 \text{ cm}^2 \text{ (usv. } 29.45 \text{ cm}^2)$$

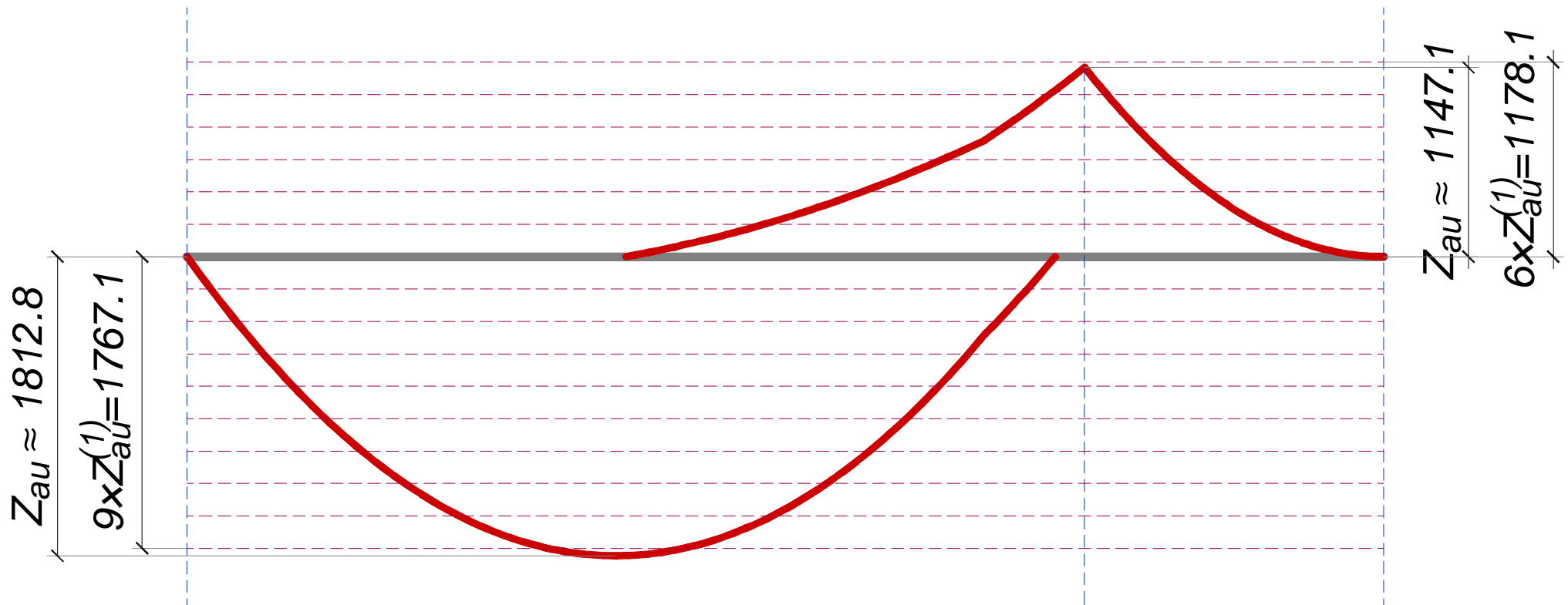

$$z = 0.964$$

$$A_{a,potr.} = 42.33 \text{ cm}^2 \text{ (usv. } 44.18 \text{ cm}^2)$$

Linija zatežućih sila

POMERANJE *M/z* linije

$$v = 0.75 \times h = 0.75 \times 68 = 51 \text{ cm}$$

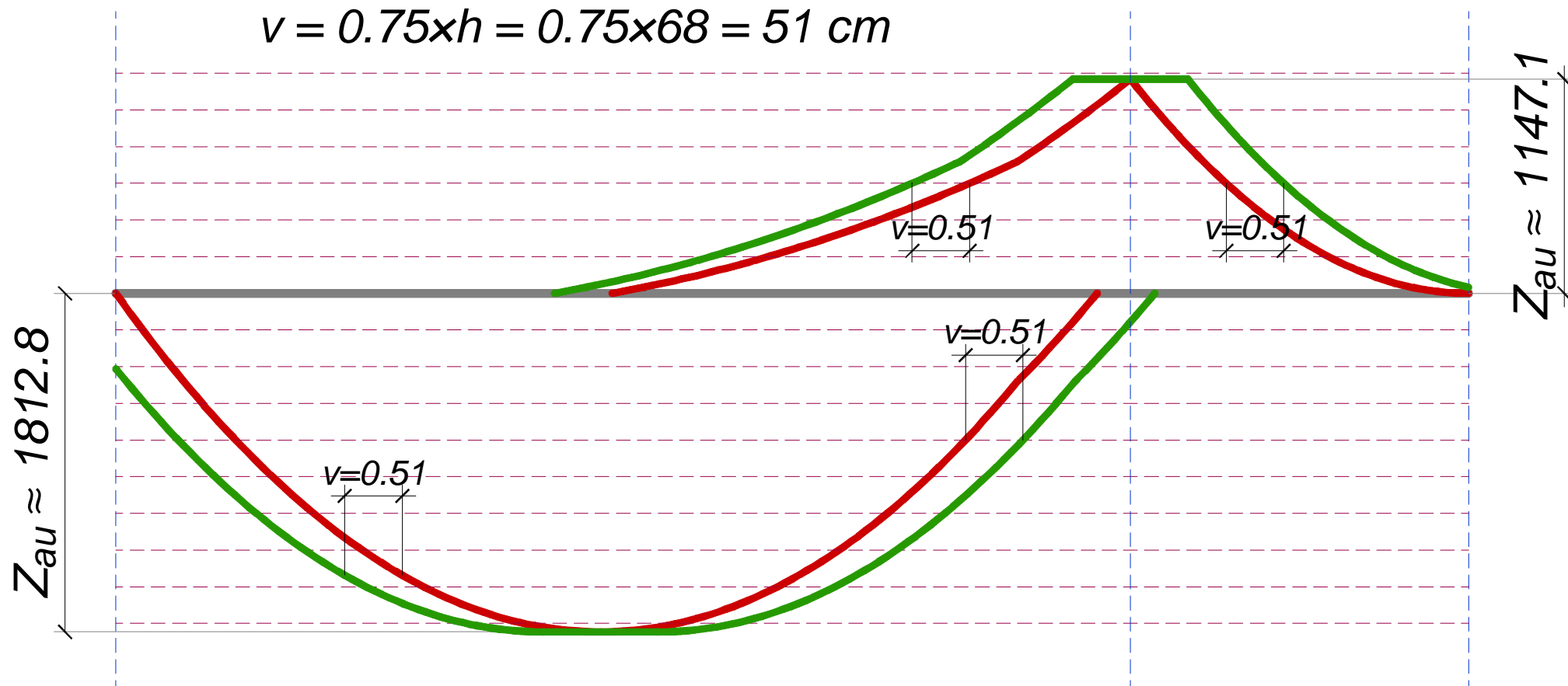

Linija pokrivanja armaturom

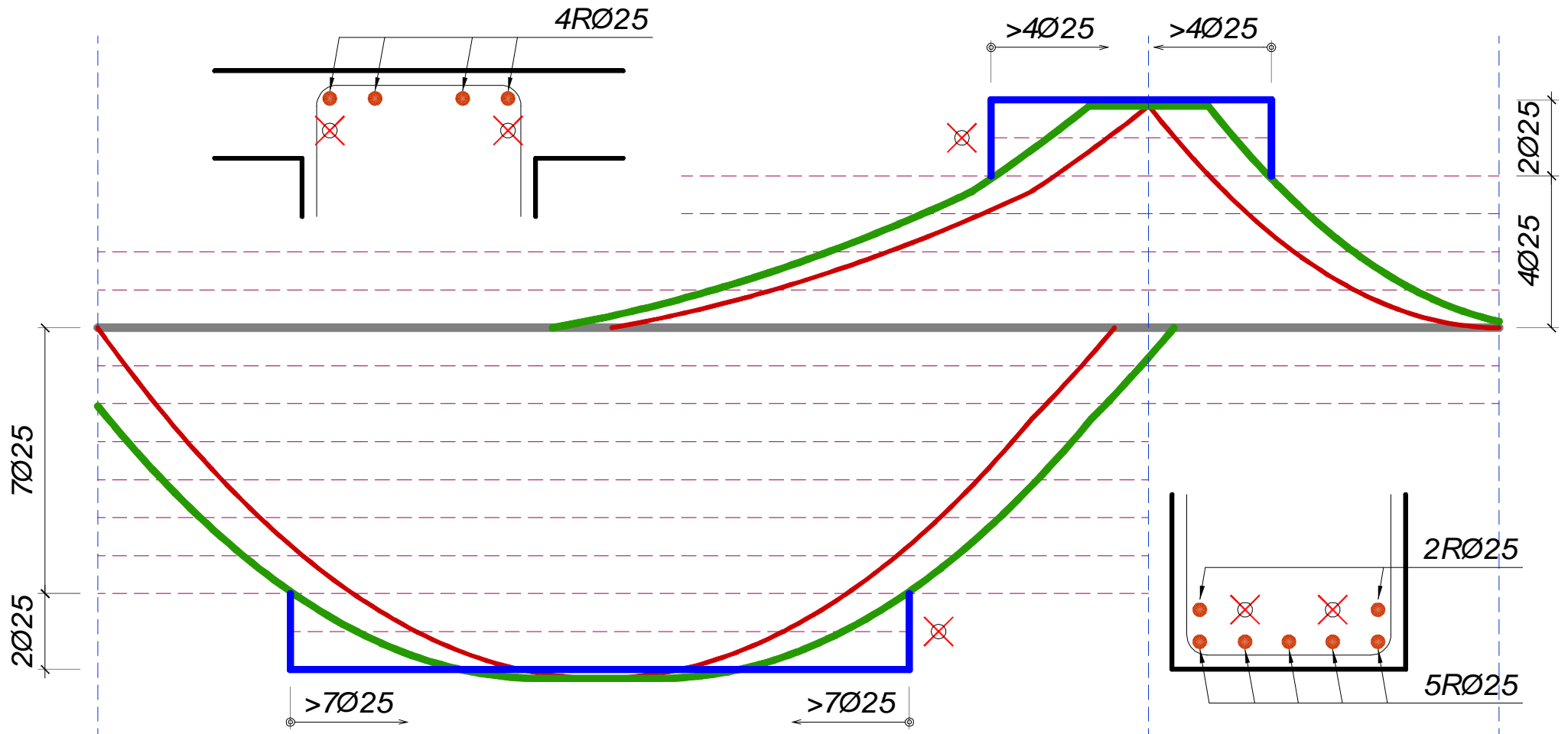

Linija pokrivanja armaturom

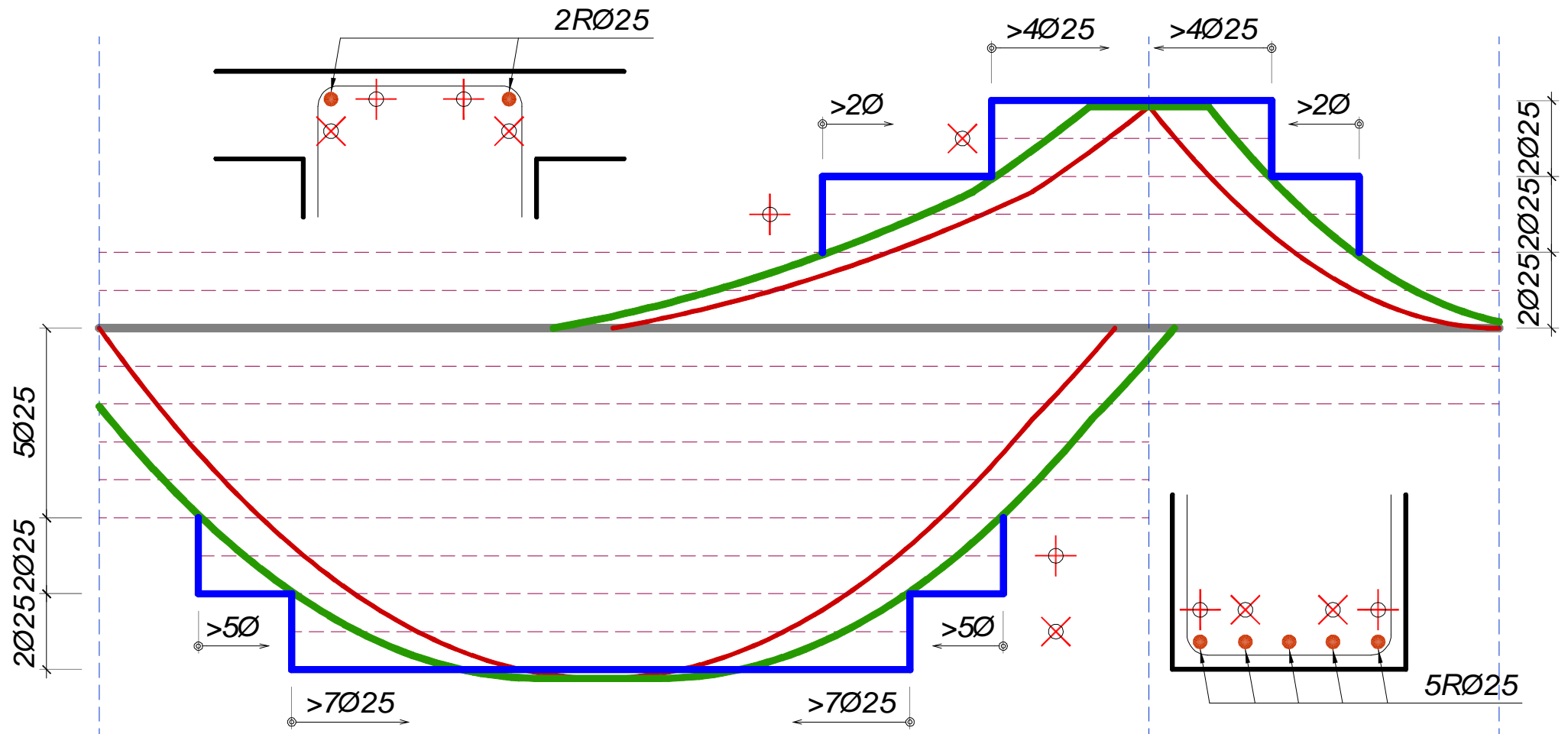

Linija pokrivanja armaturom

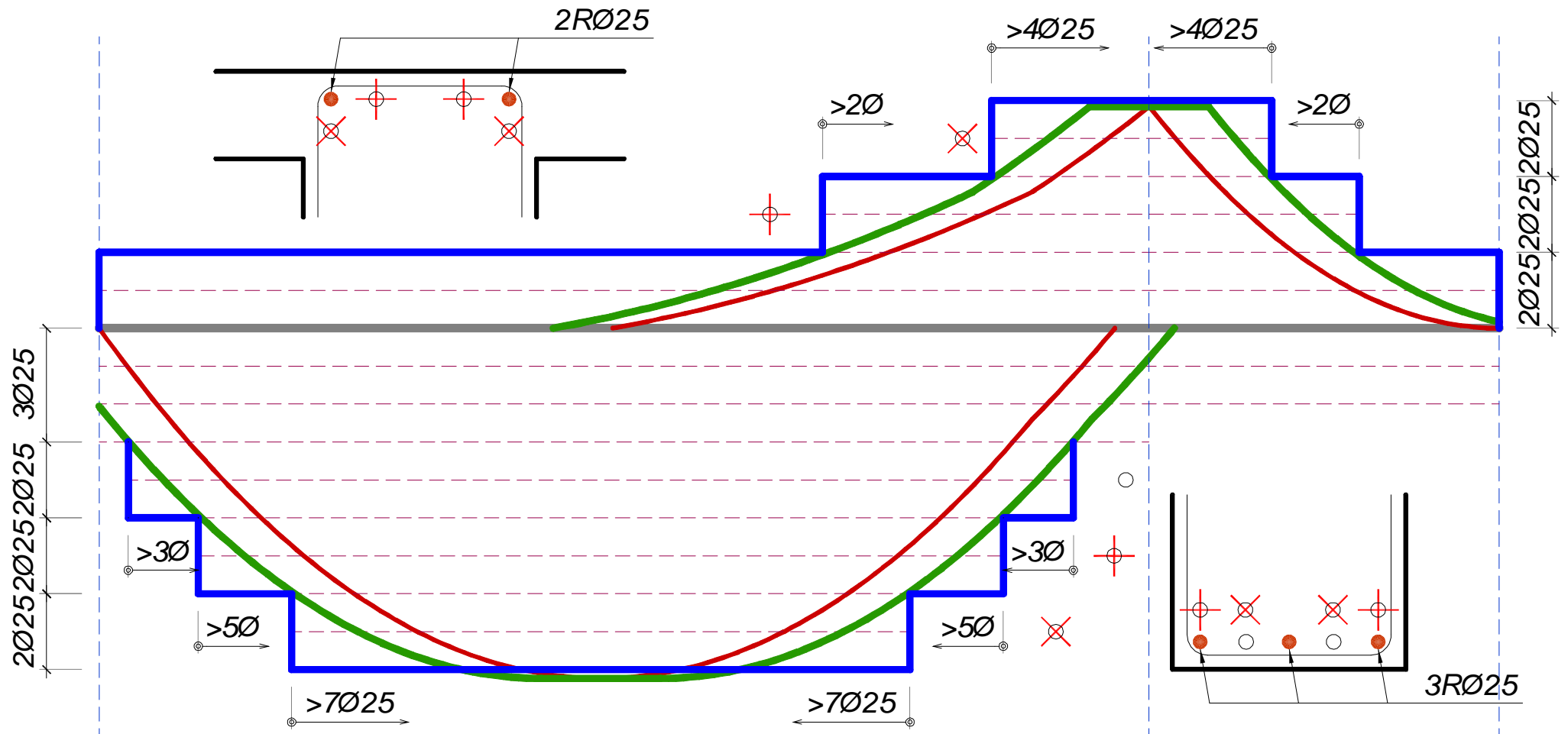

Linija pokrivanja armaturom

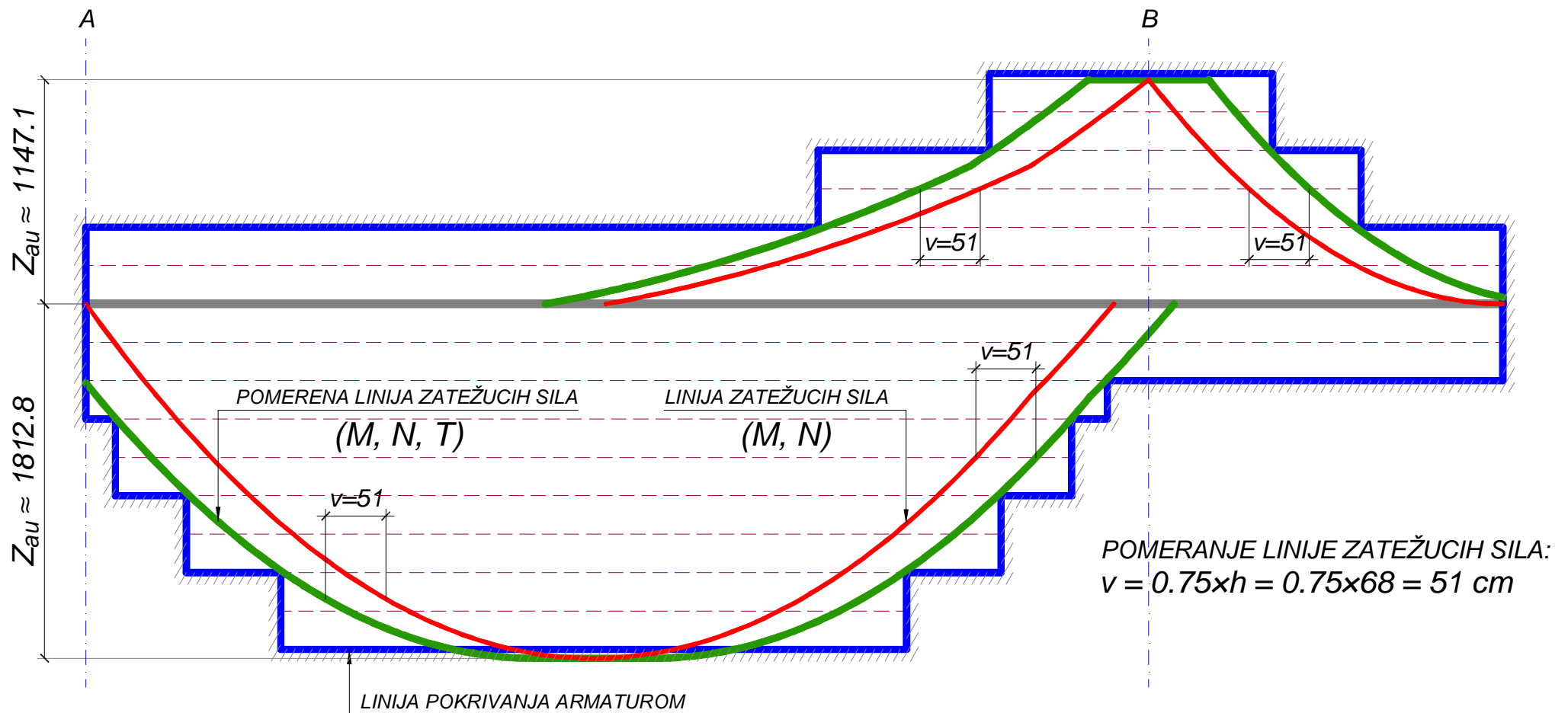

$$Z_{au} \approx M_{au} / (0.9 \times h) - N_u$$

$$M_{au} = M_u + N_u \times (d/2 - a_1)$$

$$N_u = 0: \quad M_{au} = M_u \quad ; \quad Z_{au} \approx M_u / (0.9 \times h)$$

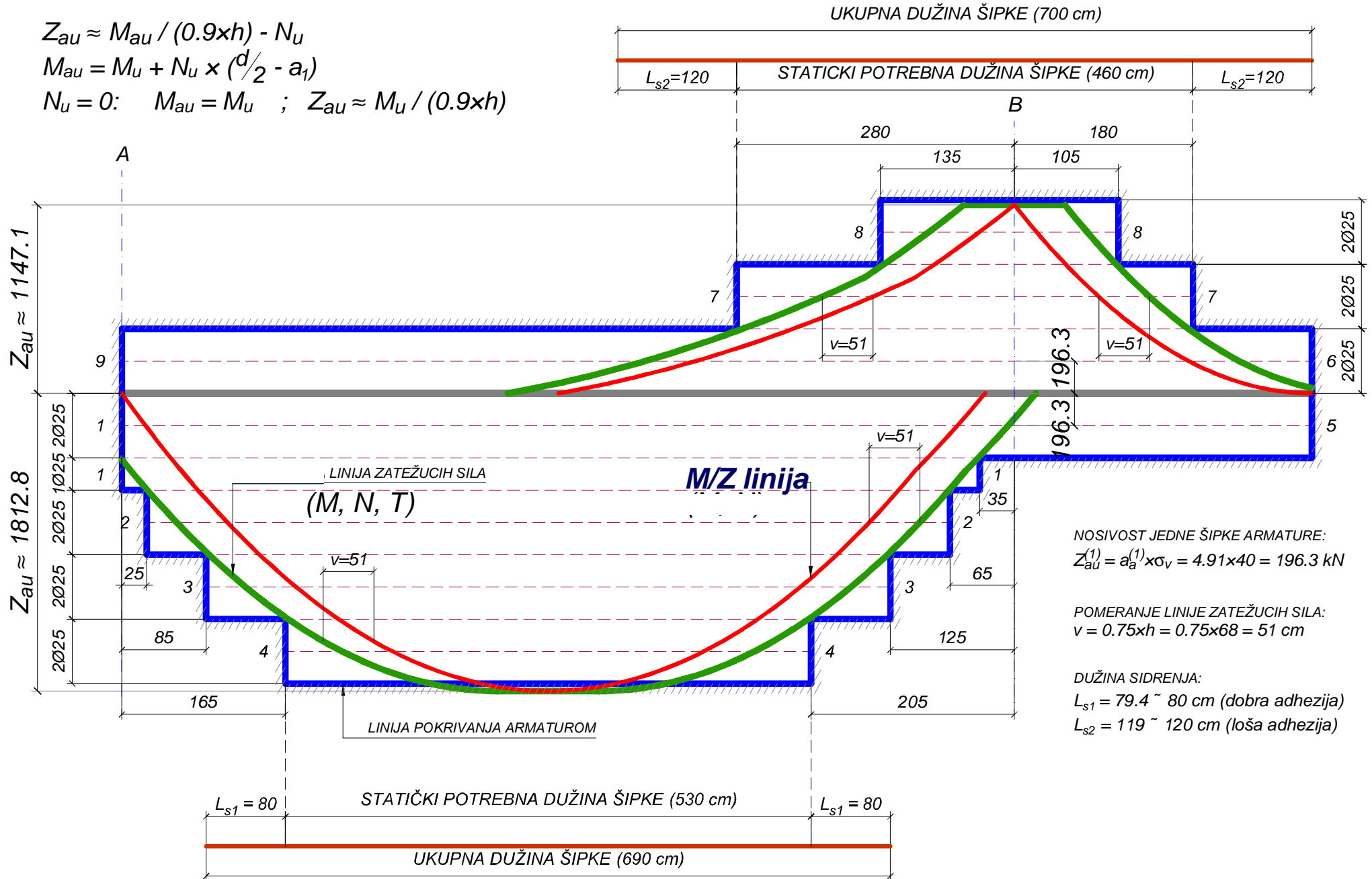

NOSIVOST JEDNE ŠIPKE ARMATURE:
 $Z_{au}^{(1)} = a_a^{(1)} \times \sigma_v = 4.91 \times 40 = 196.3 \text{ kN}$

POMERANJE LINIJE ZATEŽUCIH SILA:
 $v = 0.75 \times h = 0.75 \times 68 = 51 \text{ cm}$

DUŽINA SIDRENJA:
 $L_{s1} = 79.4 \sim 80 \text{ cm (dobra adhezija)}$
 $L_{s2} = 119 \sim 120 \text{ cm (loša adhezija)}$

4. SIDRENJE ARMATURE

Sidrenje profila armature može se vršiti pravim delom, sa kukom, sa povijanjem profila u petlju i profilima sa zavarenim poprečnim šipkama. Sidrenje pravim delom može se izvršiti na drugi način, s tim da sigurnost sidrenja šipke armature u armiranobetonskim konstrukcijama mora biti najmanje 1,8, što se mora dokazati ispitivanjem.

149

Dužina sidrenja zavisi od položaja profila u elementu pri betoniranju, od vrste čelika, od marke betona i prečnika profila armature.

Dopušteni naponi prijanjanja τ_p u uslovima dobre adhezije, zavisni su od položaja armature pri betoniranju, a odnose se:

- na armaturu koja je pri betoniranju nagnuta za 45-90° prema horizontali;
- na armaturu koja je pri betoniranju nagnuta za manje od 45° prema horizontali ili na horizontalnu armaturu, ako se profili te armature pri betoniranju nalaze u donjoj polovini poprečnog preseka elementa ili su udaljene najmanje za 30 cm od gornje slobodne površine elementa.

Dopuštene vrednosti napona prijanjanja τ_p za uslove dobre adhezije date su u tabeli 25.

Tabela 25. Dopuštene vrednosti napona prijanjanja τ_p (u MPa) za uslove dobre adhezije

Vrsta čelika	Marka betona (MB)					
	15	20	30	40	50	60
Glatka armatura (GA)	0,60	0,67	0,76	0,85	0,92	0,98
Rebrasta armatura (RA)	1,2	1,4	1,75	2,10	2,45	2,80

U ostalim slučajevima položaja armature u preseku, koji nisu navedeni u drugom stavu ovog člana, vrednosti napona prijanjanja τ_p iz tabele 25 umanjuju se za jednu trećinu za uslove lošije adhezije.

Dužina sidrenja armature (l_s) pravog dela bez kuka za glatku armaturu (GA) i rebrastu armaturu (RA) određuje se prema izrazu

$$l_s = \frac{\phi \sigma_v}{4 \tau_p \gamma_u}$$

gde je:

- ϕ - prečnik profila koji se sidri;
- σ_v - granica razvlačenja čelika, odnosno granica σ_{o2} ;
- γ_u - koeficijent sigurnosti ($\gamma_u = 1,80$) koji se odnosi na dužinu sidrenja;
- τ_p - dopušteni računski napon prijanjanja određen prema tabeli 25 za uslove dobre adhezije ili umanjen za jednu trećinu za lošije uslove adhezije.

Sidrenje armature

$$L_s = \frac{\emptyset}{4} \times \frac{\sigma_v}{1.8 \times \tau_p} = \frac{\emptyset}{4} \times \frac{400}{1.8 \times 1.75} = 31.75 \times \emptyset$$

donja zona (dobra adhezija)

$$L_{s1} = 31.75 \times 2.2 = 69.8 \text{ cm} \approx 70 \text{ cm} \quad \dots \emptyset 22$$

$$L_{s1} = 31.75 \times 2.5 = 79.4 \text{ cm} \approx 80 \text{ cm} \quad \dots \emptyset 25$$

gornja zona (loša adhezija)

$$\tau_{p2} = \frac{2}{3} \tau_{p1} \Rightarrow L_{s2} = \frac{\tau_{p1}}{\tau_{p2}} \times L_{s1} = 1.5 \times L_{s1}$$

$$L_{s2} = 1.5 \times 70 \text{ cm} = 105 \text{ cm} \quad \dots \emptyset 22$$

$$L_{s2} = 1.5 \times 80 \text{ cm} = 120 \text{ cm} \quad \dots \emptyset 25$$

Sidrenje armature

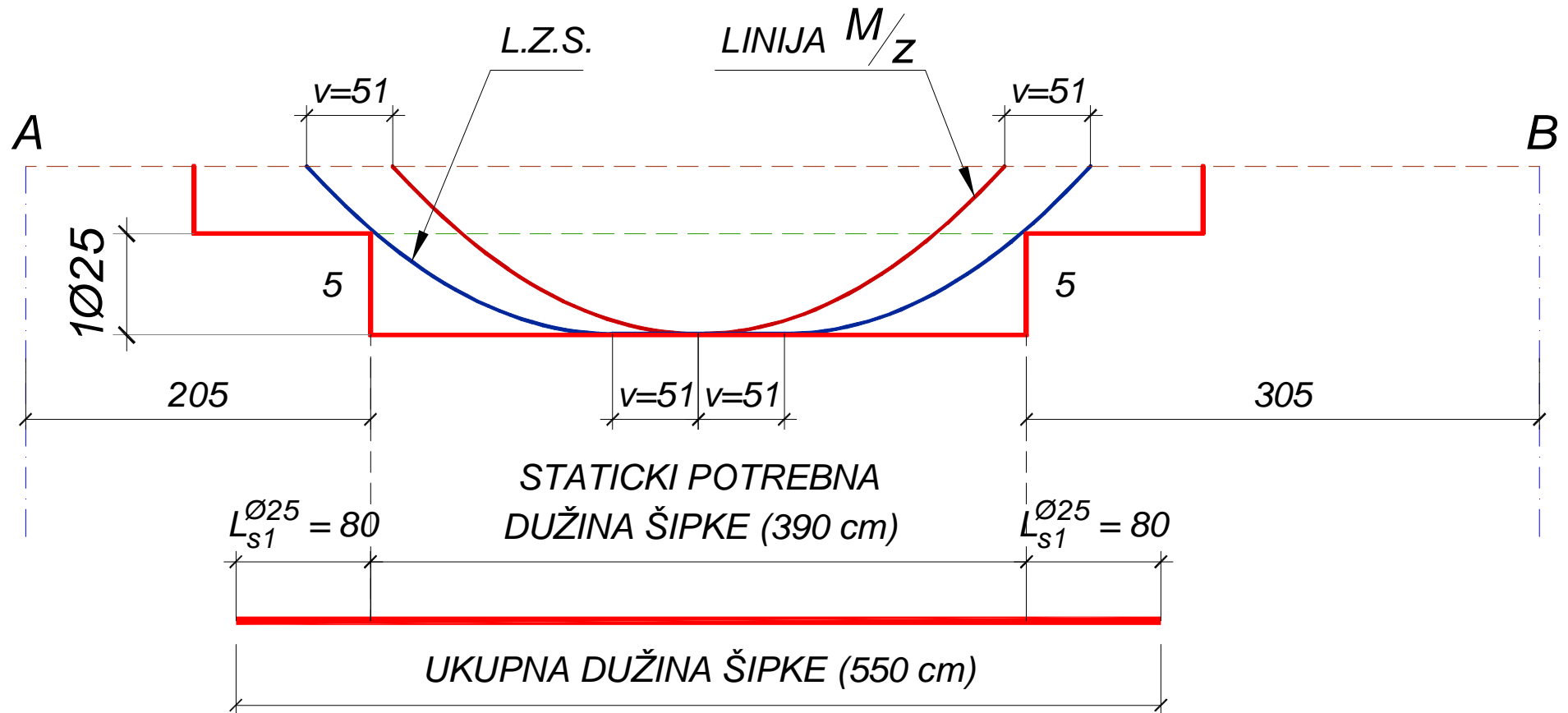

$$L_s = \frac{\text{Ø}}{4} \times \frac{\sigma_v}{1.8 \times \tau_p}$$

5. NASTAVLJANJE ARMATURE

160

Zategnuta armatura se, po pravilu, ne nastavlja preklapanjem. Ako se takvo nastavljanje ne može izbjeći, ono se izvodi u područjima najmanjih naprezanja.

Nastavljanje zategnute armature vrši se preklapanjem profila sa kukama i bez kuka, sa zavarenom poprečnom armaturom na delu preklopa ili na bilo koji drugi način, s tim da primenjeni nastavak ima sigurnost propisanu ovim pravilnikom.

Armatura se može nastavljati i elektrotopnim zavarivanjem, ali nastavak ne podleže odredbama o nastavljanju armature iz ovog pravilnika.

161

Dužina nastavka na preklop zategnute glatke armature (GA) i zategnute rebraste armature (RA) iznosi $l_p = \alpha_1 \cdot l_s(ef)$, i ne može biti manja od $l_s/2$, odnosno 15ϕ , odnosno 20 cm (slika 30).

Vrednosti koeficijenata za dužinu nastavka α_1 date su u tabeli 27.

		20%	25%	33%	50%	> 50%
$a \leq 10\phi$	$b \leq 5\phi$	1,2	1,4	1,6	1,8	2,0
$a > 10\phi$	$b > 5\phi$	1	1,1	1,2	1,3	1,4

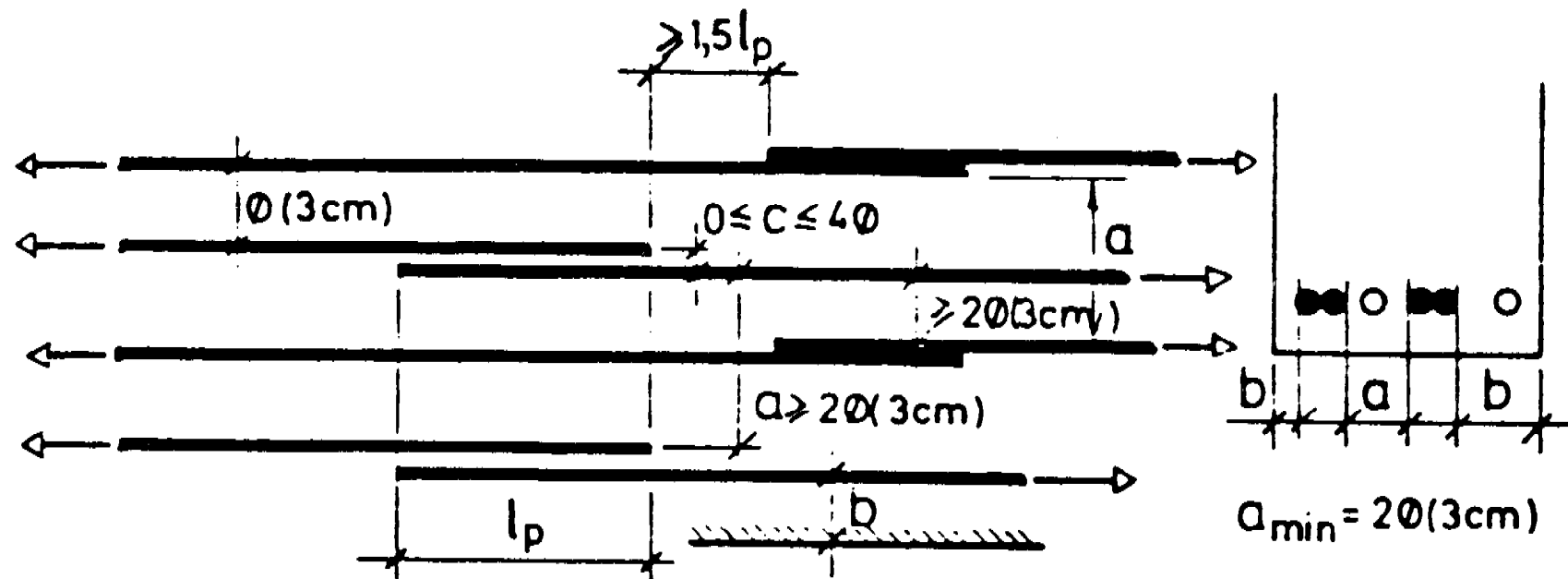

Najveći dozvoljeni procent nastavljnja zategnute armature preklapanjem u jednom preseku može iznositi:

- 100% za rebrastu armaturu ako se armatura nastavlja sa profilima $\phi < 16$, odnosno 50% za profile $\phi \geq 16$;
- 50% za glatku armaturu $\phi < 16$, odnosno 25% za profile $\phi \geq 16$.

162

Procent nastavka pritisknute armature na preklop može iznositi do 100% ukupne armature u preseku. Dužina preklapanja ne može biti manja od dužine sidrenja određene izrazom u članu 149. ovog pravilnika.

168

Podužna armatura mora se prevesti preko slobodnog krajnjeg oslonca ili krajnjeg oslonca sa delimičnim uklještenjem od najmanje trećine ukupne armature u polju za gredne nosače, a najmanje polovinu armature iz polja za ploče, s tim da ta armatura ne može biti manja od armature koja je određena izrazima iz člana 132. ovog pravilnika.

Profili armature koji se provode preko ovih oslonaca sidre se sa dve trećine efektivne dužine sidrenja određene članom 150. ovog pravilnika, računajući dužinu usidrenja od kontakta nosača i oslonca u slučaju direktnog oslanjanja, a u slučaju indirektnog oslanjanja (zona zatezanja u području sidrenja) ta dužina iznosi $l_{s(ef)}$, računajući tu dužinu od trećine širine oslonca (slika 32a i 32b).

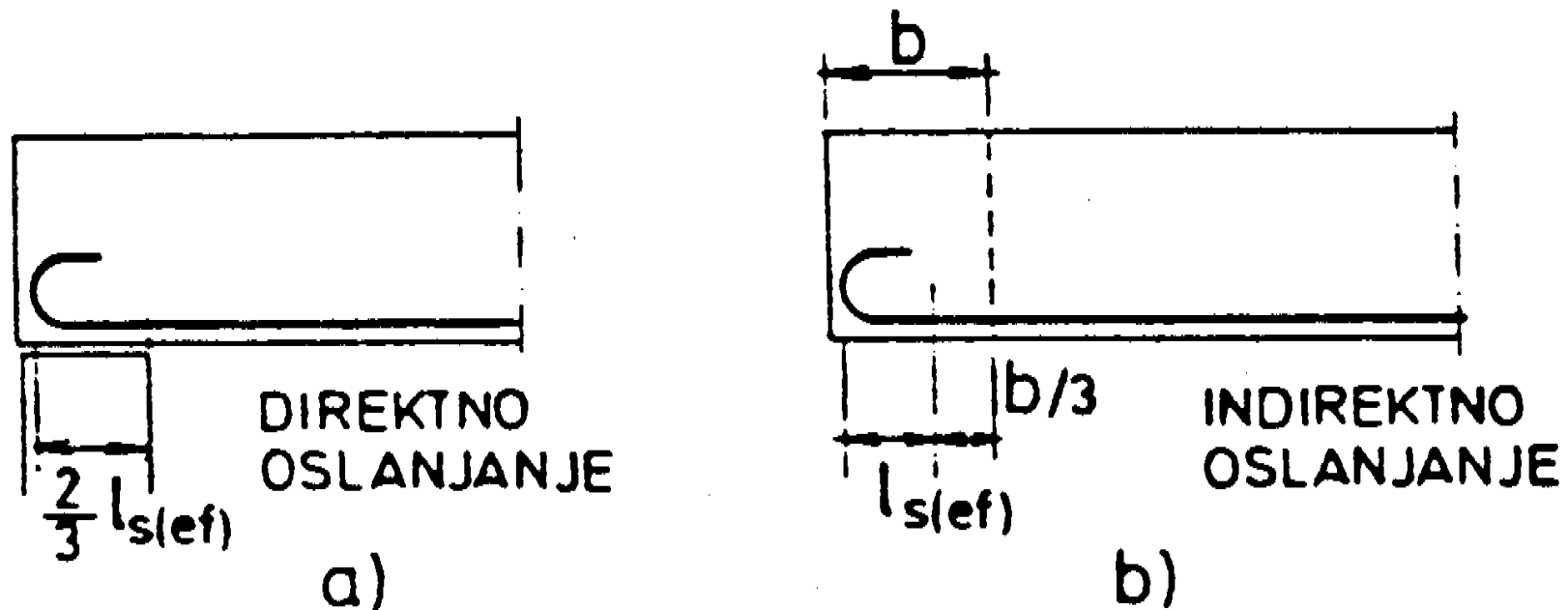

143

Standardne kuke na krajevima rebraste podužne armature su pravougaone kuke. Pravougaone kuke se oblikuju povijanjem armature za 90° , sa pravim delom dužine 8ϕ ali ne manje od 8,0 cm na kraju kuke, u produžetku krivine. Na slici 20 prikazano je povijanje rebraste podužne armature i oblik standardne pravougaone kuke. Na slici 20 date su i potrebne dodatne dužine profila Δl_k za ispravno oblikovanje kuke.

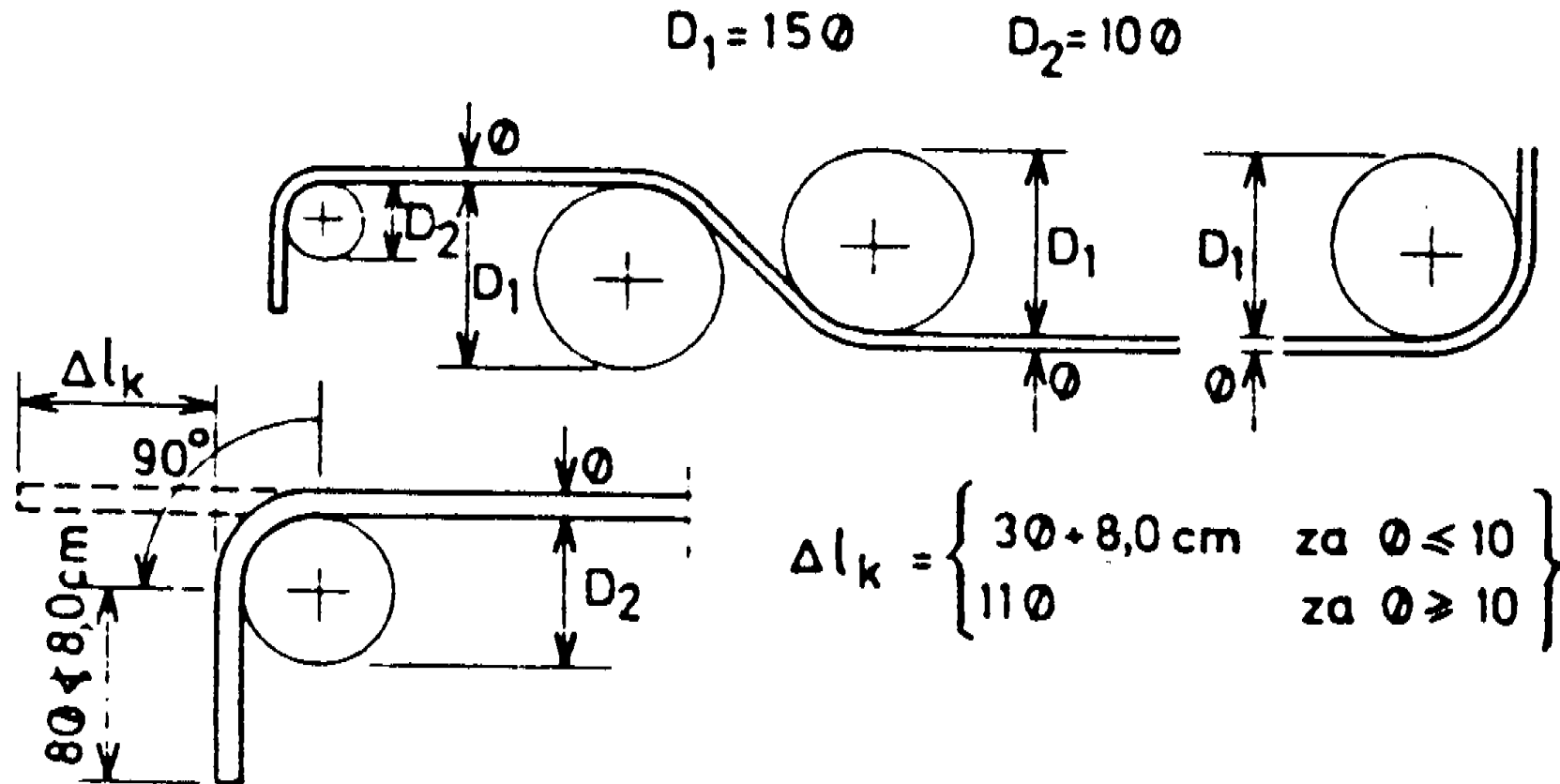

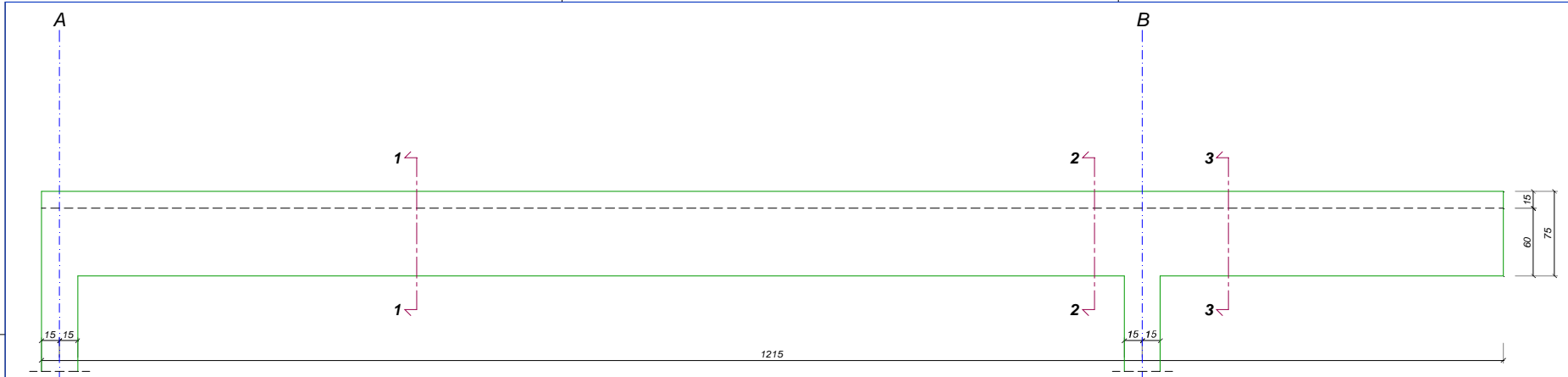

1-1

2-2

3-3

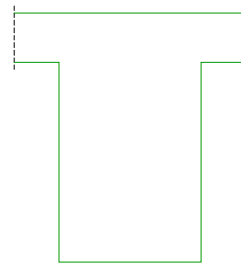
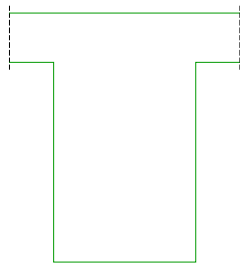
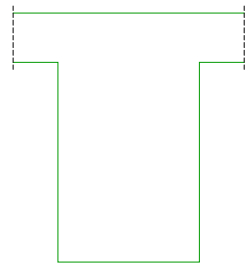

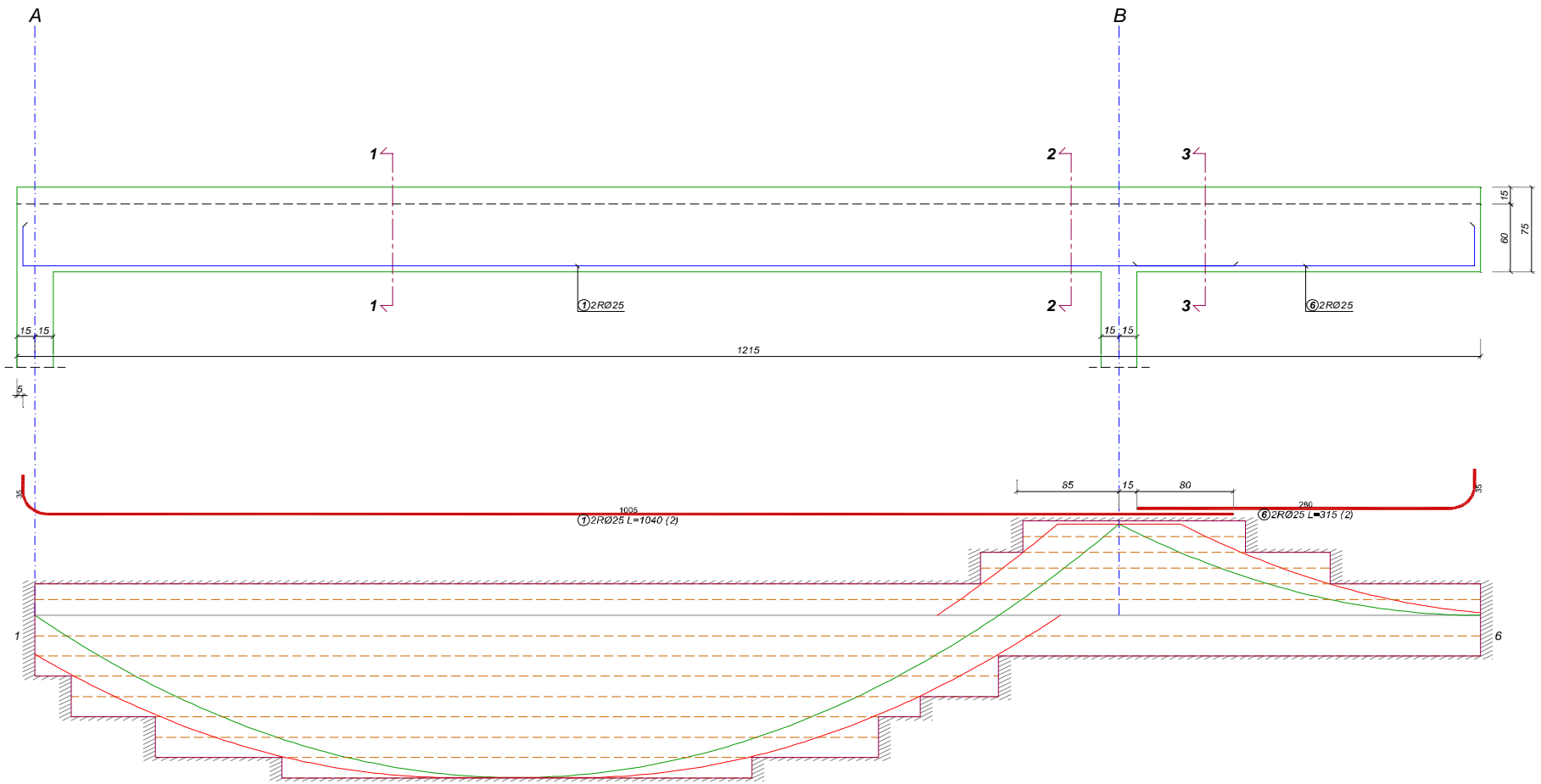

1-1

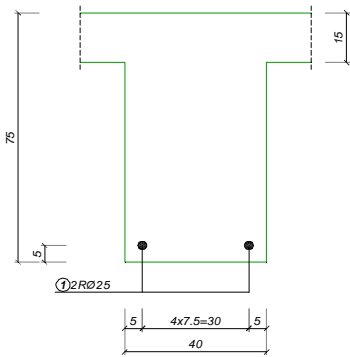

2-2

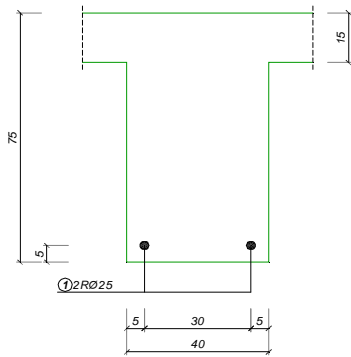

3-3

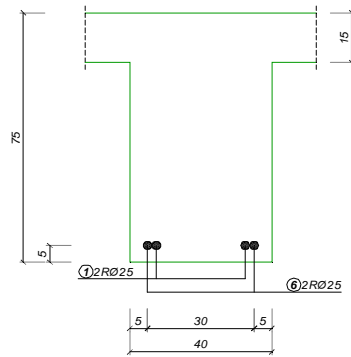

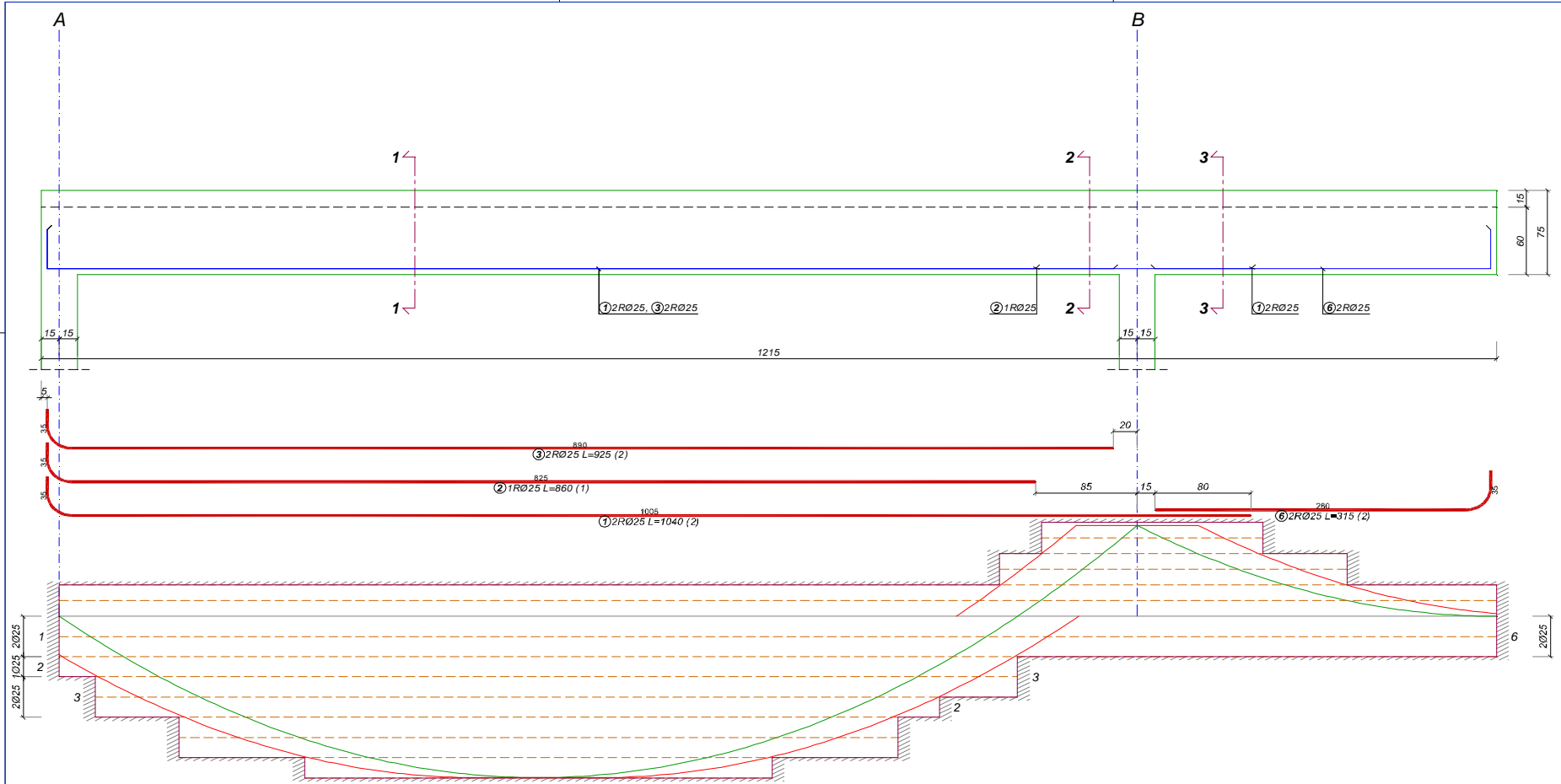

1-1

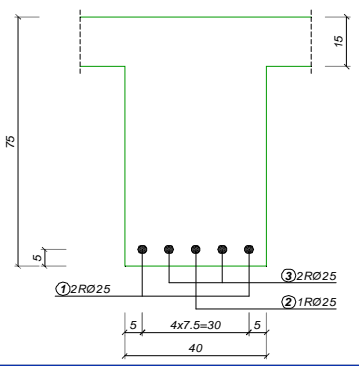

2-2

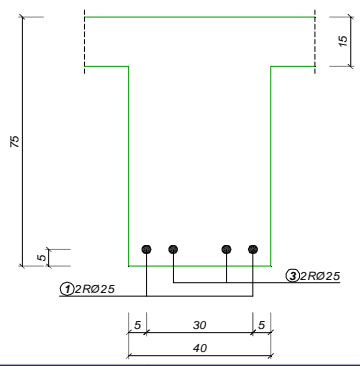

3-3

