

KOLIČINA BETONA: $V_b = 2 \times 2.05 = 4.10 \text{ m}^3$
 KOLIČINA ARMATURE: $\frac{319.23}{4.10} = 77.9 \text{ kg/m}^3$

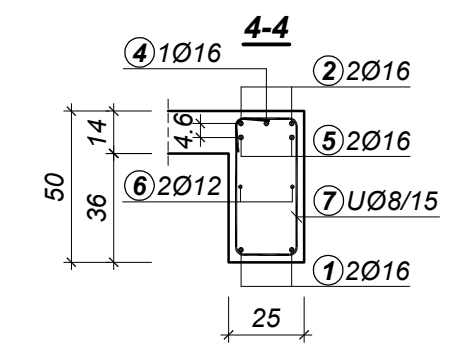
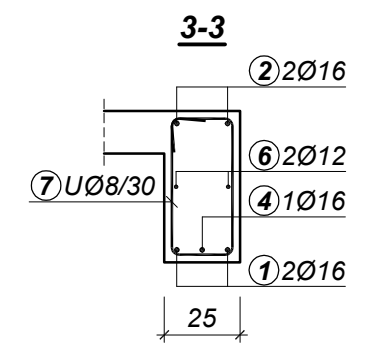
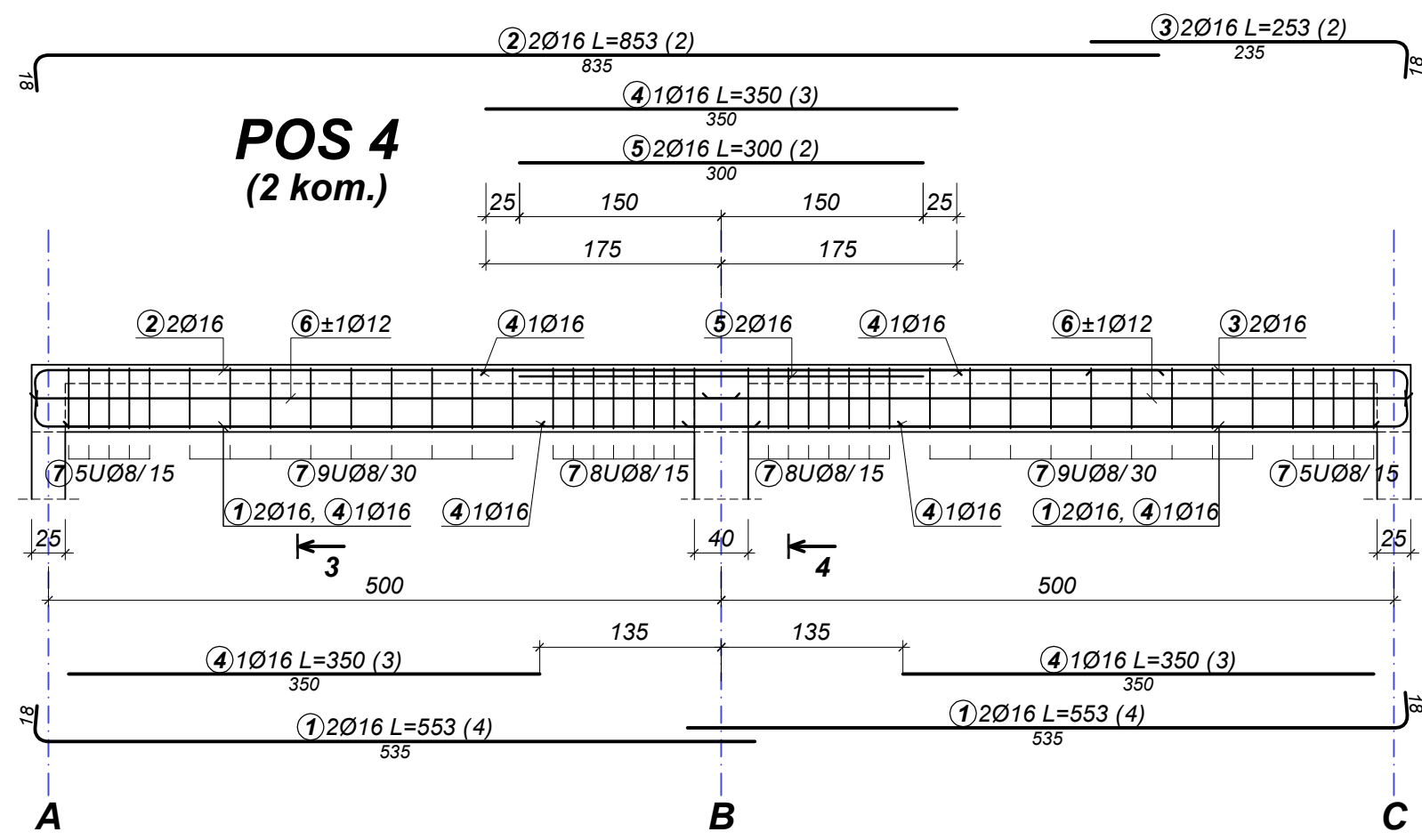
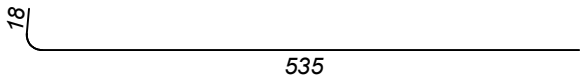
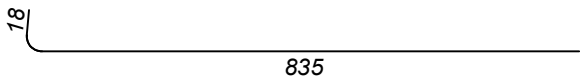
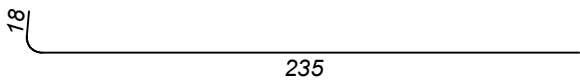
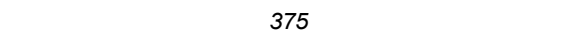
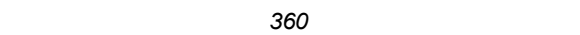
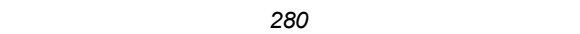
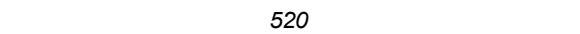
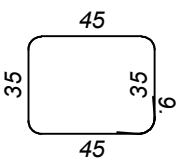

KOLIČINA BETONA: $V_b = 2 \times 1.28 = 2.56 \text{ m}^3$
 KOLIČINA ARMATURE: $\frac{287.56}{2.56} = 112.3 \text{ kg/m}^3$

GRAĐEVINSKI FAKULTET UNIVERZITETA U BEOGRADU				
MODUL MTI		KATEDRA ZA MATERIJALE I KONSTRUKCIJE		
BETONSKE KONSTRUKCIJE 2		PRIMER P03 - LIST br. 4		
PREDMETNI NASTAVNIK: PROF.DR S. MARINKOVIĆ		ASISTENT: M. STOJANOVIĆ		KANDIDAT:
PLAN ARMATURE POS 4, POS 5				
KVALITET MATERIJALA MB 30 RA 400/500	RAZMERA CRTEŽA R 1:50/20	FORMAT CRTEŽA 395×297	ŠKOLSKA 2016/2017. 10.10.2016.	OVERA:

Šipke – specifikacija uz List 4						
ozn.	oblik i mere [cm]	ozn.	Ø	lg [m]	n [kom]	lgn [m]
POS 5 (2 kom)						
1		RA2	16	5.53	8	44.24
2		RA2	16	8.53	4	34.12
3		RA2	16	2.53	4	10.12
4		RA2	16	3.75	4	15.00
5		RA2	16	3.60	4	14.40
6		RA2	16	2.80	4	11.20
7		RA2	12	5.20	8	41.60
8		RA2	8	1.78	100	178.00
Šipke - rekapitulacija						
Ø [mm]	lgn [m]	Jedinična težina [kg/m']		Težina [kg]		
RA2						
8	178.00	0.405		72.09		
12	41.60	0.911		37.90		
16	129.08	1.621		209.24		
Ukupno						319.23

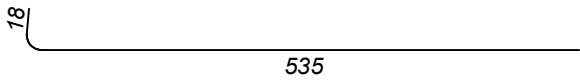
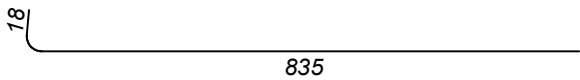
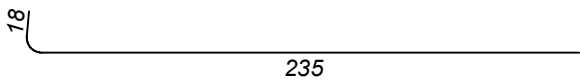
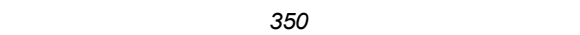
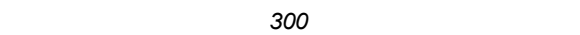
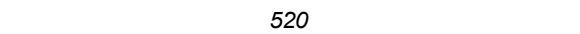
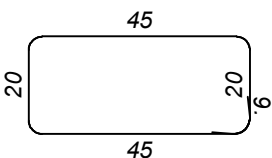
Šipke – specifikacija uz List 4						
ozn.	oblik i mere [cm]	ozn.	Ø	lg [m]	n [kom]	lgn [m]
POS 4 (2 kom)						
1		RA2	16	5.53	8	44.24
2		RA2	16	8.53	4	34.12
3		RA2	16	2.53	4	10.12
4		RA2	16	3.50	6	21.00
5		RA2	16	3.00	4	12.00
6		RA2	12	5.20	8	41.60
7		RA2	8	1.48	88	130.24
Šipke - rekapitulacija						
Ø [mm]	lgn [m]	Jedinična težina [kg/m']		Težina [kg]		
RA2						
8	130.24	0.405		52.75		
12	41.60	0.911		37.90		
16	121.48	1.621		196.92		
Ukupno						287.56

Šipke – rekapitulacija uz List br.4				
Ø [mm]	lgn [m]	Jedinična težina [kg/m']		Težina [kg]
RA2				
8	308.24	0.405		124.84
12	83.20	0.911		75.80
16	250.56	1.621		406.16
Ukupno				606.79